

SANYANG MOTOR CO.,LTD.

3 CHUNG HUA ROAD HUKOU HSINCHU TAIWAN,R.O.C.

TEL:886-3-598-1911 FAX:886-3-598-1844

E-mail:SERVICE@sym.com.tw

<http://www.sym.com.tw>



Owner's Manual



FS05W2-EU SERIES

FS05W2-NL SERIES



1.CONTENTS

1. Contents	1
2. Control location	3
3. Before riding	4
4. Safe riding	4
5. Driving	5
6. Use genuine spare parts	5
7. Use of each component	6
Gauges	6
Operation of ignition switch	8
Operation of steering handle lock switch	8
Operation of fuel tank cap switch	8
Use of buttons	9
Storage box.....	10
Safety helmet hook	11
Fuel tank cap	11
Brake	11
8. Important points and cautions for starting engine	12
9. The best way to drive off	13
The control of throttle valve handle	13
Parking method	13
10. Inspection and maintenance before riding	14
Routine inspection	14
Engine oil inspection and change	14
Fuel inspection.....	15
Transmission oil inspection and change	15
Inspection and adjustment of brake free play	16
Disc brake inspection (depending on models)	17
Throttle valve handle clearance adjustment	18
Inspection and maintenance of battery	18
Tire inspection	19
Steering handle front shock absorbers inspection	19
Checking and changing fuses	20
Checking the turn signal lights and horn	20
Checking the front and rear lights	20
Checking the brake light	20

1.CONTENTS

Checking for fuel leakage	21
Checking the lubrication of body's various mechanisms	21
Checking the spark plug	21
Checking the air cleaner	21
11. When there is an abnormal condition or a trouble	22
Diagnosis when engine does not start	22
12. Suggestions on engine fuel	22
13. Transmission oil	22
14. Cautions for riding motorcycle	23
15. Periodical maintenance schedule	24
16. Specification	26

2.CONTROL LOCATION

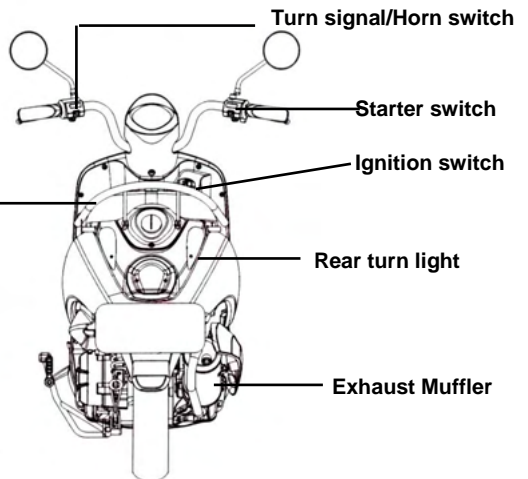
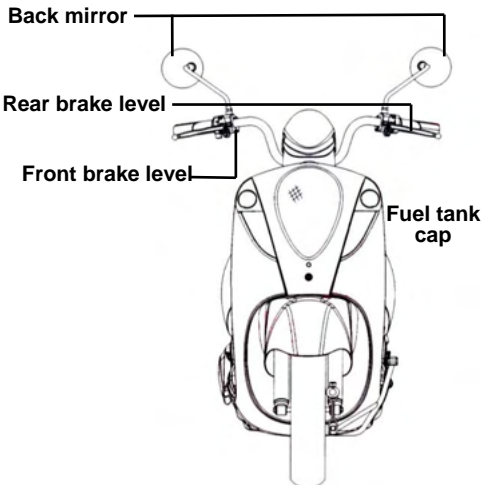
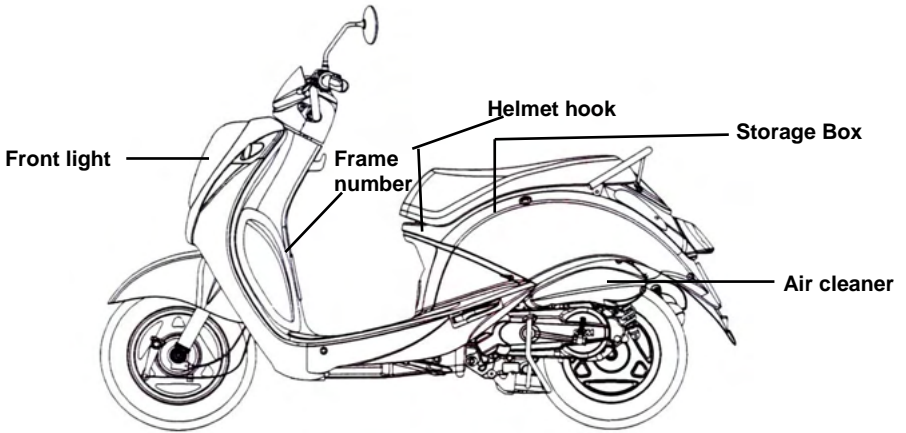
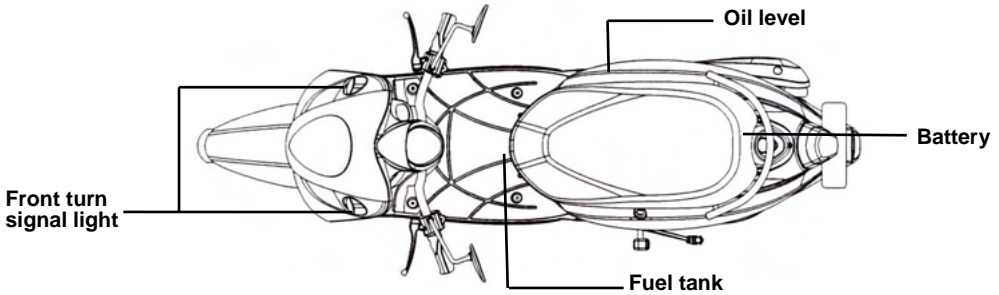

3. BEFORE RIDING

This manual describes the correct usage of this motorcycle including safety riding, simple inspection methods and so on.

For a more comfortable and safety riding, please read this manual carefully.

For your benefit, please ask your SYM dealer the operating manual and carefully read the following:

- Correct use of the motorcycle.
- Pre-delivery inspection and maintenance.

Thank you very much for your patronage

In order to maximize your motorcycle's performance, a periodical inspection and maintenance should be completely carried out.

We recommend that after riding your new motorcycle for the first 300 kilometers, you should take your motorcycle to the original dealer for an initial inspection, and to have your motorcycle inspected periodically every 1000 kilometers thereafter.

- In case the motorcycle's specifications and construction are modified and different from the photos and diagrams on the owner's manual / catalogues, the specifications and construction of the actual motorcycle shall prevail.

4. SAFE RIDING

It is very important to be relaxed and clothe properly when driving, observe traffic regulations, do not rush, always drive carefully and relaxed.

Usually, most people would ride their newly bought motorcycle very carefully, but after they became familiar with their motorcycles, they tended to become reckless which may result in an accident.

To remind you:

- Please wear a safety helmet, and properly tighten the chin belt when riding a motorcycle.
- Clothes with open or loose cuffs may be blown by wind and cause the cuffs to get caught on the steering handle and thus affects riding safety.
- So, put on clothes with tight sleeves.
- Hold the steering handle by both hands when riding. Never ride with only one hand.
- Observe the speed limit.
- Wear suitable low-heel shoes.
- **Perform periodical maintenance and inspection in accordance with the schedule.**

WARNING!!

- To avoid getting burned by exhaust pipe when taking a passenger. Make sure your passenger has put his/her feet on the pedals.
- After running, the exhaust pipe is very hot, be careful not to get burned when conducting an inspection or maintenance.
- After running, the exhaust pipe is very hot, select a suitable location to park your motorcycle to avoid others getting burned by the exhaust pipe.

CAUTION:

Modified motorcycle will affect its structure or performance, and cause poor engine operation or exhaust noise, which will result in shortening the motorcycle's service life.

Besides, modification is illegal and does not conform to the original design and specifications.

A modified motorcycle will not be covered by warranty; therefore, do not modify your motorcycle at will.

5.DRIVING

- **Keep the related parts of your body such as arms, palms, lumbar, and toes relax and ride with the most comfortable posture in order to be able to react quickly whenever it is necessary.**
- Rider's posture will greatly affect riding safety. Always keep your body's gravity in the center of the saddle, if your body's gravity is on the rear part of saddle, the front wheel load will be reduced, and this will cause the steering handle shaking. It is dangerous to ride a motorcycle with an unstable handle.
- It will be much easier to make a turn if rider inclines his body inward when turning. On the other hand, the rider will feel unstable if his body and the motorcycle do not incline.
- The motorcycle is hard to control on a bumpy, unleveled, unpaved road, try to know the road conditions in advance, slow down and use your shoulder's force to control the handle.
- Suggestion: Do not load objects on the front pedals unnecessarily, to avoid affecting the riding safety and the operation of steering handle.

CAUTION:

The rider's feeling on the handle is slightly different with a load or without a load. Overload may cause the handle to swing and affects the riding safety. Therefore, do not overload your motorcycle.

CAUTION:

- Do not place flammable materials such as rags between the body side cover and engine to avoid components damaging by fire.
- Do not load objects on areas not specified for loading to avoid damage.

SUGGESTION

To maximize the motorcycle's performance and prolong its service life:
The first month or first 1000km is the wear- in period for the engine and components.

6. USE GENUINE SPARE PARTS

In order to maintain the motorcycle's best performance, each part's quality, material, and machined precision must conform with the design requirements. "**SYM Genuine Spare Parts**" were made from the same high quality materials used for the original motorcycle. No parts would be sold to the market until they could meet the designed specifications through sophisticated engineering and stringent quality control. Therefore, it is necessary to purchase "**SYM Genuine Spare Parts**" from "**SYM Authorized Dealers**" when replacing spare parts. If you buy cheap or fake substitute parts from the market, no guarantee can be provided either for the quality or durability. Also, it may result in unexpected troubles and lower the motorcycle's performance.

- Always use **SYM Genuine Spare Parts** to keep your motorcycles pure blood and to ensure its long service life.

7.USE OF EACH COMPONENT

(The following is SYM 4 stroke air-cooling scooter's basic operation, and they could vary from different individual models. Please consult the end of this manual.)

§GAUGES §

The panel figure for speedometer may vary from model to model, but the location usually are the same.

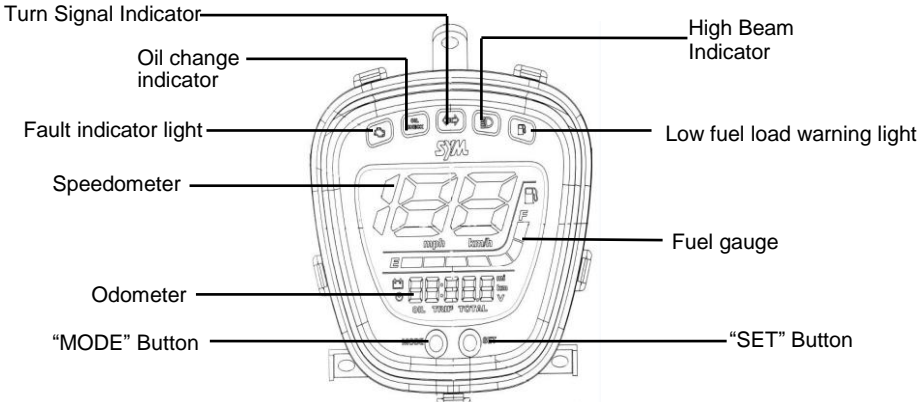

- **Speedometer :**
Indicates driving speed.
- **Odometer :**
Indicates total accumulated distance traveled.
- **High Beam Indicator :**
This indicator comes on with high beam headlight is turned on.
- **Turn (left/right) Signal Indicator :**
The left or right Indicator will be flashing according to the operated directions of turn signal light switch when it is turned on.
- **Fuel Gauge:**
The pointer in this gauge shows how much fuel remains in the tank.
The pointer stays in "E" position when key switch is turned to "OFF".
- **Fault indicator light**
If there is something wrong with the ECU, the warning light will light all the time.

Oil change indicator:

It is used to indicate the oil exchange time, with lights, when the vehicle was driven about 1000 kilometers, indicator light will light up, warn the users to replace the oil.

• **Low fuel load warning light:**

When there is a little fuel inside the tank, the warning light will be on.

“MODE” button:

1. When the key switch is turned to “ON”, Press “MODE” button to change
TOTAL → TRIP → CLOCK → VOLTAGE
- 

“SET” button

1.Engine oil change warning lamp

It is used to indicate the oil exchange time, with lights, when the vehicle was driven about 1000 kilometers, indicator light will light up, warn the users to replace the oil.
After finish oil change, in ODO mode, long press SET key 2 + 0.5 seconds or more, then the indicator light will go out. the lamp will reset

Mileage Setting:

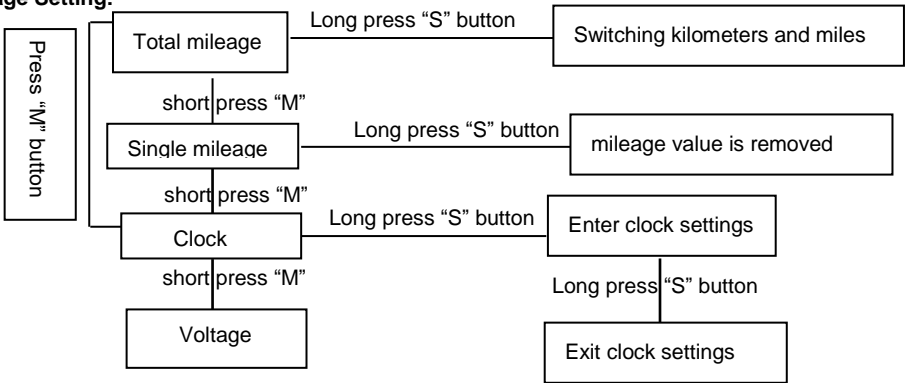

“CLOCK” SET

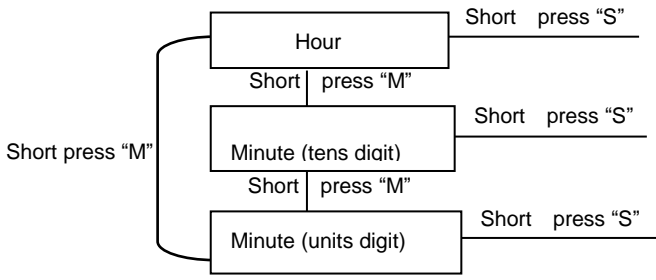

§OPERATION OF IGNITION SWITCH §

IGNITION SWITCH

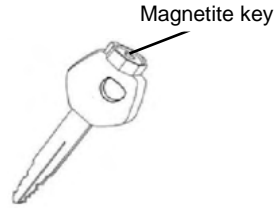
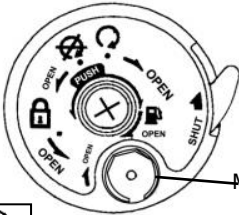

“ON” position:

- Engine can be started in this position.
- Ignition switch key can not be removed.



“OFF” position:

Engine is shut off and can not be started in this position .

- Ignition switch key can be removed.

§OPERATION OF STEERING HANDLE LOCK SWITCH §



“Steering handle lock” position

- Turn the steering handle to left and insert the key into, press ignition switch key clockwise and then lightly turn it to left to the “lock” position.
- The steering handle is locked in this position.
- Ignition switch key can be removed.
- When unlocking, simply turn the key from the “LOCK” position to the “OFF” position.



CAUTION:

- Make sure to take the key away with you before you lock your

§OPERATION OF FUEL TANK CAP SWITCH§



“Fuel tank cap open” position :

- How to open : Insert your key into the ignition switch, and turn it to the right.
- How to lock : Push the fuel tank cap and it locks automatically

§OPERATION OF IGNITION§



“OPEN” position:

- The keyhole baffle can be moved to open by turning the “open “after contact and pointing at the magnet switch keyhole



“SHUT” position:

Directly press the black button next to the “shut “button and the keyhole shutter can be closed by automatically popping the keyhole baffle.

MAGNETITE KEY :

- Insert your magnetite key into the magnetite keyhole, and turn it to right ignition keyhole block board can be to open.
- When close ignition keyhole. You just push the Ignition keyhole block board push rod, and ignition keyhole can be to close.

⚠ CAUTION:

- Never operate the ignition switch key when the motorcycle is running. To turn the ignition switch to "OFF" and "LOCK" position will shut off the electrical system and that may result in a dangerous accident. Therefore, the ignition switch can only be turned off after the motorcycle has been completely stopped.
- Always remove the key and be sure to take the key away with you after locking the steering handle before leaving your motorcycle.
- If ignition switch remains in the "ON" position for a prolonged period after the engine has been stopped, the battery's capacity will be reduced and this may affect the engine's start ability.
- Make sure to take the key away with you before you lock your seat.

§USE OF BUTTONS §

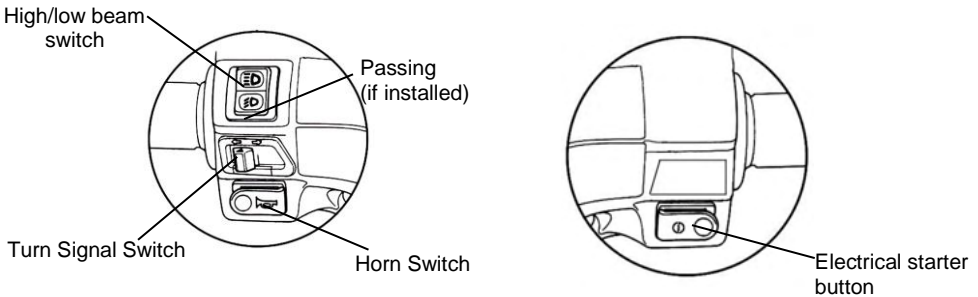

• Electrical starter button



This is a starting motor button (switch) for engine starting.

With the main switch "on", press this button while holding the front or rear brake lever will start the engine.

⚠ CAUTION:

- Release this button immediately after engine has been started, and never press the button again to avoid damaging the engine.
- This mechanism is a safety design. The engine can only be started after the front or rear brake lever (pedal) has been applied.

• High/low beam switch

This is the high and low beam of headlight switching switch. Press this switch to switch between high and beams.



This is for high beam.



This is for low beam.(please turn to low beam riding in city.)

passing switch (if installed)

Passing Turn ignition switch to the “ON” position and press this button down. Then, the high beam of headlight will come on immediately to warn the driver of the vehicle ahead that you intend to overtake him/her.(For overtake, high beam indicator will come on at this time)

- This button will return to original position after releasing

Horn Switch



Press this button down when ignition switch is in the “ON” position, the horn will sound.

• Turn Signal Switch

Turn signal lights are used when turning left/right or changing lane.

Turn ignition switch to the “ON” position, and slide the turn signal switch to left or right . Then, the turn signal lights will flash.

To release, simply return the turn signal light button to the original position.



Right-side turn signal light flashing means you intend to make a right turn.



Left-side turn signal light flashing means you intend to make a left turn.

§STORAGE BOX§

- This box is located under the seat.
- Maximum load capacity:5kg.
- Do not store valuables in the box.
- Make sure that the seat has been locked completely after it was pressed down.
- Take out valuables before washing to avoid wetting these objects.
- Do not place thermal sensitive objects in the box because of engine's heat and high temperature.

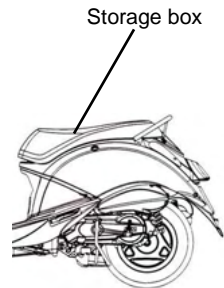

§SAFETY HELMET HOOK§

- Stop the motorcycle, and hook the safety helmet chin belt to the hook.

CAUTION:

- Do not hang the safety helmet onto this hook when riding to avoid damaging motorcycle and losing safety helmet's function.

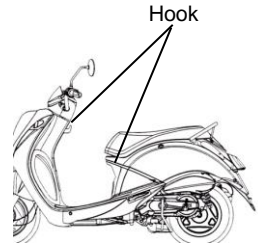

§FUEL TANK CAP§

1. Insert the key into the ignition switch and rotate to the right ,the fuel tank cap will pop up automatically.
2. Do not fill above the fuel upper limit when refueling.
3. Align the “△”mark on the cap with the “△”mark on the fuel tank, then depress the fuel cap clockwise .

CAUTION:

- Main stand should be put down on the ground, engine should be shut off and flames should be strictly prohibited to ensure safety when refueling.
- Do not fill above fuel upper limit when refueling. Otherwise, fuel will flow out through a hole on the cap that may damage the body's painting, in serious cases; it may cause a fire to burn down the motorcycle.
- Make sure the cap has been tightened properly.

§BRAKE§

- Avoid unnecessary sudden braking.
- Use front and rear wheel brakes simultaneously when braking.
- Avoid brake continuously for a long period of time because that may overheat the brakes and reduce its braking efficiency.
- Slow down and brake early when riding in rainy days on slippery roads. Never apply the brakes suddenly to prevent skidding and falling.
- Using only the front brake or the rear brake increases the risk of falling because the scooter is tend to pulled to one side.

《Engine Brake》

Return the throttle valve handle back to its original position, and apply engine brake.

It is necessary to apply brake both for front wheel and for rear wheel intermittently when riding on a long or stiff slope.

For Rear Wheel



For Front Wheel



8. IMPORTANT POINTS AND CAUTIONS FOR STARTING ENGINE

CAUTION:

- Please check the oil and fuel volume are adequate or not before starting the engine.
- To start the engine the main parking stand must be firmly on the ground and the brake is applied on the rear wheel to prevent the motorcycle from moving forward suddenly.

1. Turn ignition switch key to the "ON" position.
2. Apply hand rear wheel brake.
3. Do not accelerate, press starter button when the brake is applied.

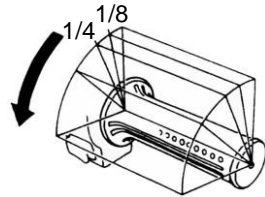
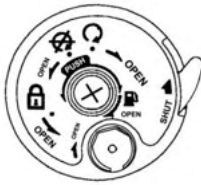

[We care for you! Before drive off, keep the hand brake applied on the rear wheel.]

CAUTION:

- If engine can not be started after press the kick starter arm for 3~5 times, turn the throttle valve handle 1/8~1/4 turns, and then press the kick starter arm again for an ease start.
- In order to avoid damaging the starter motor, please do not press the starter button continuously over 15 seconds.
- If engine still can not be started after pressing starter button over 15 times, stop and wait for 10 seconds before start it again.
- It is harder to get the engine started after the motorcycle has been left idle for a long time or after refueling only after the fuel has been depleted. Then, it is necessary to press starting lever or starter button several times, and keep the throttle valve handle at the close position to start the engine.
- It may need several minutes to warm up engine if it is a cold start.
- Exhaust contains harmful gases (CO), therefore please start the engine at a well ventilated place.

[When starting engine with starting lever.]

- After step 1~3 is completed, press the kick starter forcefully by foot with the throttle valve handle at the close position.
- If engine is cold and it is difficult to start, rotating the throttle valve 1/8~1/4 turns will make the start easier.
- Put the kick starter back to its original position after the engine has been started.

CAUTION:

- Firmly support the motorcycle with the main parking stand before starting the engine with the kick starter arm.
- Starter engine with the kick starter arm occasionally to prevent it from loosing its function because of unused for a long time.

9. THE BEST WAY TO DRIVE OFF

- turn on the turn signal light before moving, and make sure no vehicle is coming from behind. Then, drive off.

§ THE CONTROL OF THROTTLE VALVE HANDLE §

Acceleration : To increase speed. When riding on an inclined road, turn the throttle valve handle slowly to allow the engine to output its power.

Deceleration : To decrease speed.

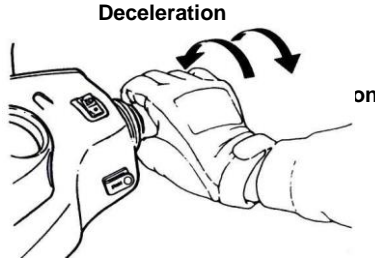

§ PARKING METHOD §

- when approaching the parking lot:
 1. Turn on the turn signal light early, and pay attention to the vehicles in front, from rear, left and right, then take the inner lane and approach slowly.
 2. Return the throttle valve handle back to its original position, and apply brakes in advance. (Brake light comes on when braking to warn drivers of vehicles behind.)
- **When stop completely:**
 3. Press the turn signal switch back to its original position, and turn the ignition switch key to the "OFF" position to shut off the engine.
 4. Get off the motorcycle from left side after the engine has been stopped, and select a parking place where the motorcycle will not interfere with traffic and the ground is level, then put down motorcycle's main parking stand.
 5. Hold the steering handle with your left hand, and hold down the front end of saddle or hold the parking handle on the lower-left side of saddle with your right hand.
 6. Press the main parking stand with your right foot, put down the main parking stand firmly on the ground.

To remind you: Lock the steering handle and remove the key after parking to prevent the motorcycle from being stolen.



CAUTION:

- Park your motorcycle at a safe place where it will not interfere with traffic.

10.INSPECTION AND MAINTENANCE BEFORE RIDING

(Please refer to the components location diagram for the following components.)

§ROUTINE INSPECTION §

Check Items		Check Key Points
Engine Oil		Is there enough engine oil?
Fuel		Is it enough? Is it Octane 90 or above
Brake	Front	Braking condition? (Brake lever free play: 10~20mm)
	Rear	Braking condition? (Brake lever free play: 10~20mm)
Tires	Front	Is tire pressure normal? (Standard: 1.75kg/cm ²)
	Rear	Is tire pressure normal? (Standard: 2.0 kg/cm ² for 1 person, 2. 25 kg/cm ² for 2 persons)
Steering Handle		Does the handle vibrate abnormally or is difficult to turn?
Speedometer, lights, and rearview mirror		Is it operated properly? Do lights come on? Can it be seen clearly from behind?
Tightness of Main Components		Are screws, nuts loosen?
Abnormal Points		Do the previous troubles still exist?



CAUTION:

- If any problem founded during routine inspection, correct the problem before using the motorcycle again, have your motorcycle checked and repaired by the “**SYM dealer or authorized service personnel**” if necessary.

§ENGINE OIL INSPECTION AND CHANGE §

• INSPECTION:

1. Use the main parking stand to support the motorcycle on a level ground, remove the dipstick after engine stopped for 3~5 minutes. Wipe oil off the dipstick and then insert it into the guide tube again (Do not rotate it.)
 2. Remove the dipstick and check whether oil level is in between the upper and lower marks.
- Add oil to upper limit if oil is under the lower limit. (Check cylinder, crankcase...etc for leakage.)

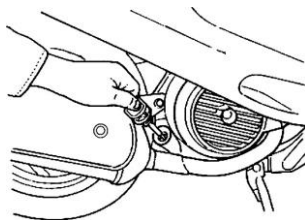

OIL CHANGE:

- Change engine oil after the first 300km, and change the engine oil every 1000km thereafter.
- In order to maintain the engine's maximum performance, check whether the engine oil is enough every 1000km. Add oil to upper limit if the engine oil has been found to be inadequate.
- Engine Oil : Use (API)SJ MA 10W-30 grade or better engine oil. (especially suggest USE SM 10W-50) Otherwise, damage will not be covered by warranty.
- Oil Capacity : 0.8Liter (0.7 liters for routine change).
- Use SAE 5W-40 when outside temperature is below 0°C.

[Oil Filter Cleaning]

The oil filter nut assembly of the element, and remove the element. Remove the foreign materials from the element by using a gasoline or air spraying gun.



WARNING:

- Oil level will not be correct when checking the oil level with the motorcycle parked on an unlevelled ground or immediately after the engine stopped.
- Engine and exhaust pipe are hot right after engine stopped. Pay special attention not to get burned when checking or replacing engine oil.
- If the oil lever approaches lower limit again after refilled, check the engine for leaks and refill it again.
- Keep away from spark and flames when refilling the oil.

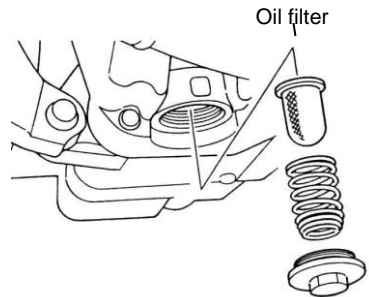
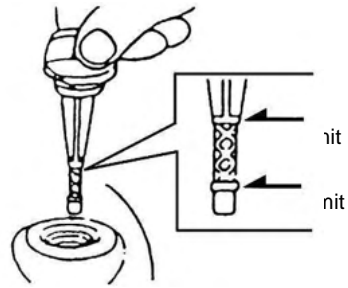

Avoid oil emulsification

- Warming up at regular intervals
- Warm car runs in a minute every time
- At least run 10 km once a month
- Replace oil when 3 months or 1000km

§FUEL INSPECTION§

- Turn main switch key to "ON" position, and check fuel gauge's needle range to make sure there is enough amount of fuel in the fuel tank.
- This motorcycle's engine is designed for using the unleaded fuel of Octane 90 or above.
- Firmly secure the main stand on the ground, shut off the engine and keep flames away from the motorcycle when refueling.
- Do not fill above fuel upper limit lever when refueling.
- Make sure the fuel tank cap had been tighten properly.

§TRANSMISSION OIL INSPECTION AND CHANGE§ INSPECTION:

- Use the main stand to support the motorcycle on a level ground, after the engine stops, wait for 3~5 minutes. Remove the transmission oil infusion bolt, put a measuring glass under the drain bolt, and remove the drain bolt. Let the oil flows into measuring glass and check for decreased or not. (at disassembly:110c.c./at change:100c.c.).

OIL REPLACEMENT:

- stop the engine and use the main stand to support your motorcycle on a lever ground. Remove the infusion bolt and drain bolt, drain out the oil.
- Install the drain bolt and tighten it. Fill new transmission oil (100c.c.), and install the infusion bolt and tighten it. (Make sure that bolts are tightened and check that there's no leakage.)
- Recommend Oil: Genuine SYM HYPOLD GEAR OIL (SAE 85W-140).

§INSPECTION AND ADJUSTMENT OF BRAKE FREE PLAY§

INSPECTION: (Brake lever free play must be checked with the engine shut off.)

- Brake lever and pedal free play for front and rear wheels.
- ◆ If checking the hand-braking lever for front wheels, its free play (the stroke of hand-braking lever from no braking to initial braking) should be 10~20mm. It is abnormal if the feel is spongy when holding the hand-braking lever forcefully.

10~20 mm

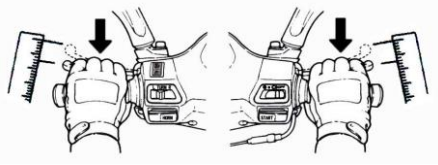

Adjustment: (Drum type)

- The indentation of brake adjustment nut must be aligned with the pin. (see below figure)

Adju:

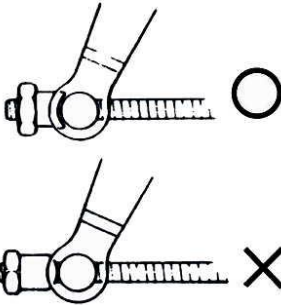

⚠ CAUTION:

When free play is between 10~20 mm, check brake indicators of front and rear wheels. If the arrow on the brake arm aligned with the “△” marked on the brake disk, that means the brake lining has been excessively worn, and must be replaced immediately.

- Turn the adjustment nut on brake arm of front and rear wheels to adjust the free play of hand-brake lever.
- Hold the hand-brake levers after adjusting with both hands until there is effective brake feeling.
- Measure the free play with a ruler.

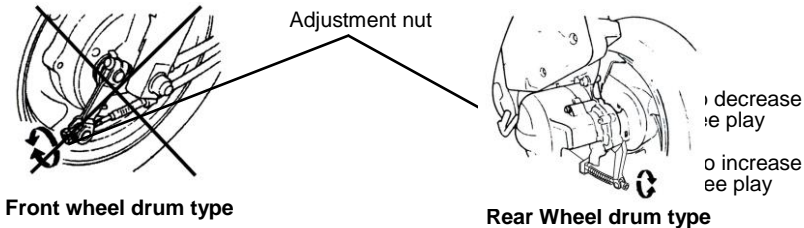

§DISK BRAKE INSPECTION§

- Visual check brake lines for leakage, or damage, check brake lines connections for looseness using a wrench or similar tool, and check whether steering handle vibration in driving, or any parts' interference may have damage the brake lines. If so, bring your motorcycle to your SYM dealer for repairing or service.



⚠ CAUTION:

- Please drive your motorcycle on a dry road surface slowly and operate front and rear brakes in order to find out if there is any malfunction so as to ensure the motorcycle is at optimum condition and safe ride.

the brake disk.

(Checking oil quantity in brake oil reservoir)

- Park the motorcycle on a level ground, and check if fluid level is under the "LOWER" mark. Recommended Brake Fluid: WELL RUN BRAKE OIL (DOT 3).

(Checking front brake lining)

- check the brake from behind the brake caliper. The brake pad must be replaced with new lining when the brake pad wear limit reaches

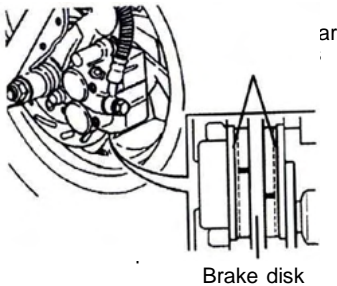

Brake disk

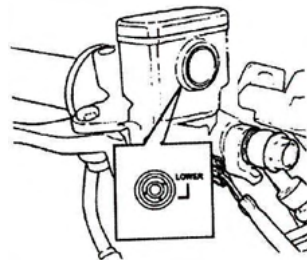

Screw

(Replenishment of front wheel brake fluid)

1. Loosen the screws and remove the master cylinder cover.
2. Wipe clean foreign materials, dirt around the reservoir, being careful not to let foreign materials fall into the reservoir.
3. Remove the diaphragm plate and the diaphragm.
4. Add brake fluid to upper lever.
5. Install the diaphragm plate and the diaphragm, and install the master cylinder cover.
5. please note the diaphragm direction, and do not let foreign materials fall into the reservoir. And tighten the master cylinder cover securely.

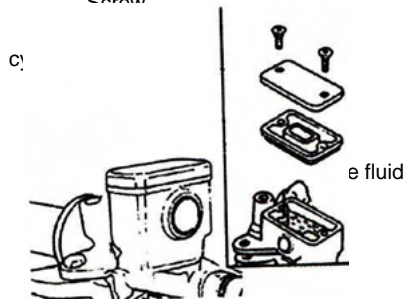

fluid

⚠ CAUTION:

- TO prevent chemical reaction, please do not use brake fluids other than those recommended.
- Do not fill above the upper limit when adding brake fluid and avoid dropping on painting or plastic components to prevent damage.

§THROTTLE VALVE HANDLE CLEARANCE ADJUSTMENT §

- Correct clearance allows throttle valve handle to rotate 2–6mm.
- Loosen the lock nut first, then turn the adjust nut to adjust. Tighten the lock nut securely when finished.

Check Items:

1. Check throttle valve cable to see if it can be moved smoothly from a closed position to a wide open position.
2. Rotate steering handle from side to side to check if the throttle valve cable is interfered.
3. Check to see if the throttle valve cable is obstructed by other cables preventing it from being operated smoothly.

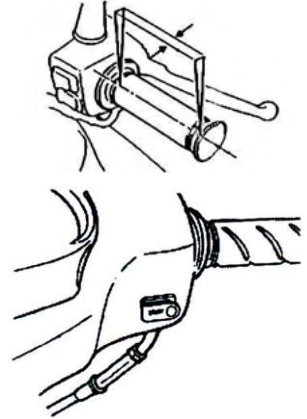

§INSPECTION AND MAINTENANCE OF BATTERY §

- The motorcycle is equipped with a maintenance-free type battery, so it is unnecessary to check and add electrolyte. Have your motorcycle checked by SYM Authorized Dealer should any abnormality is found.

(Cleaning of battery terminals)

- Remove the battery terminals and clean if there are dirt and corrosion on them.
- Battery removal procedures are as follows: Turn ignition switch key to the "OFF" position, then remove negative cable screw firstly and disconnect the negative cable. Then, remove positive cable screw and positive cable.

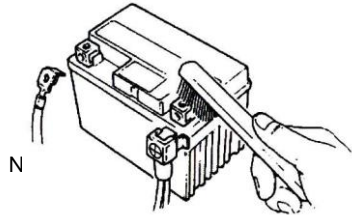

⚠ CAUTION:

- Clean the battery posts with warm water if the posts are eroded and have some white powders on them.
 - If there is an obvious erosion on the terminals, disconnect the cables, and then clean the erosion off with a steel brush or a piece of sandpaper.
 - Install battery cable after cleaning and apply a thin coat of grease on the terminals.
 - Install battery in reverse order of removal.
- The motorcycle is equipped with a maintenance-free type battery, so it is unnecessary to check and add electrolyte. Have your motorcycle checked by SYM Authorized Dealer should any abnormality is found.

⚠ CAUTION:

- This is a closed type battery. Never remove the caps.
- In order to prevent electric leakage and self-discharge when the battery sits idle for long periods. Remove battery from motorcycle; store it in well-ventilated and dimly lighted place after the battery has been fully charged. Disconnect battery's negative cable if the battery is still kept on the motorcycle.
- If the battery needs to be replaced, replace with a same closed-type battery (Maintenance-Free).

§TIRE INSPECTION §

- Tires should be checked and inflated with the engine shut off.
- If a tire's ground contacting curve is abnormal, check it with an air pressure gauge and inflate it to the specified pressure.
- Tires pressure must be checked with an air pressure gauge when cold.

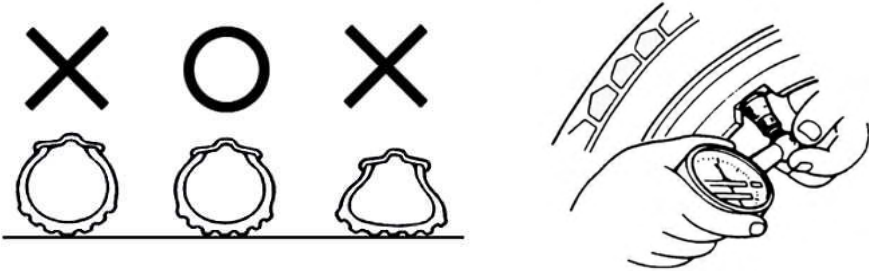

PLEASE REFER TO SPECIFICATIONS FOR STANDARD TIRE PRESSURE

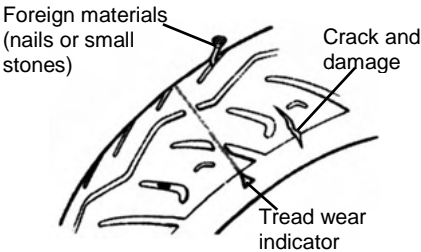

- Visual check tires for frontal and lateral side walls for crack or damage.
- Visual check tires for any nails or small stones wedged in the tread.
- Check the “tread wear indicator” condition to see if tread groove depth is insufficient.
- A tire with a wear bar showing is worn out and should be replaced immediately.

⚠ CAUTION:

- Abnormal tire pressure, wear, or crack is the most important cause that results in the loss control of the steering handle and a punctured tire(s).

§STEERING HANDLE FRONT SHOCK ABSORBERS INSPECTION §

- Perform this check with engine shut off and ignition switch key removed.
- Visual check front shock absorbers for damage.
- Operate steering handle up and down, and check front shock absorbers for noises due to bends.
- Check the bolts and nuts of front shock absorbers with wrenches for tightness.
- Shake steering handle up & down, left & right, and front & rear to check if it is loosen, has too much resistance and pulls to one side.
- Check steering handle if it is being pulled too tight by the brake cables.
- Take your motorcycle to SYM Authorized Dealer for a check or adjustment if any abnormal conditions are found.

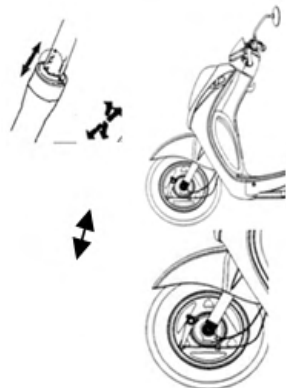

§CHECKING AND CHANGING FUSES §

Turn off ignition switch, and check fuses if they are intact. Replace the blown fuse with a new one having the same specified amperage rating (20A/15A*2/10A). Using a fuse of more than (20A/15A*2/10A) amperes, a brass or iron wire to replace a blown fuse is strictly prohibited to avoid damaging the electrical system and the circuit.

- Remove the storage box, and you'll find the fuse holder near battery.
- Open the fuse box cover, and pull out the fuse. Check it for damage or broken.
- Fuses must be firmly secured with wire connectors when replacing. Loose connections will result in overhead and damage.
- Use only parts having the specified specification to replace electrical components such as light bulbs. Using parts not having the specified specifications for replacement may cause the fuse to blow and over-discharge the battery.
- Avoid spraying water directly on or around fuse box when washing the motorcycle.
- If the new fuse burn out quickly again, please check the faulty reason before replace it again. Take your motorcycle to your dealer for an inspection if a fuse is blown by unknown causes.

【REMOVE】

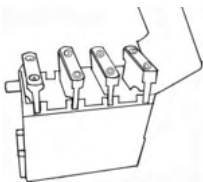

【INSTALLATION】

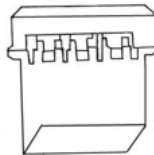

§CHECKING THE TURN SIGNAL LIGHTS AND HORN §

- Turn the ignition switch key to the "ON" position.
- Make sure that the front & rear and left & right signal lights flashes and also check if the warning buzzer sounds.
- Check turn signal light covers if they are dirty, crack, or loosen.
- Press horn button to check if it works.

⚠ CAUTION:

- Specified specification bulbs should be used for turn signal lights. Otherwise, the normal operation of turn signal lights will be affected.
- Turn on the turn signal light before turning or switching lane to warn driver of vehicles behind.
- Turn off the turn signal light immediately by pressing its button down after using. Otherwise, the flashing of twin signal lights may confuse the drivers of vehicles behind.

§CHECKING THE FRONT AND REAR LIGHTS §

- Start engine the head lamp is turned on automatically. Check if head lamp and rear lamp come on.
- Check the brightness and direction of front light by wall to see if it is correct.
- Check the head lamp cover if it is dirty, crack, or loosen.

§CHECKING THE BRAKE LIGHT §

- Turn the ignition switch key to the "ON" position, hold the hand-braking levers for front and rear wheels. Check if the brake lights come on.
- Check the brake light cover if it is dirty, crack, or loosen.

⚠ CAUTION:

- Use only specified specification bulbs, do not use bulbs with different specifications to avoid damaging electrical system, burning out bulbs, and discharging the battery.
- Do not modify or add other electrical components to prevent over load or short circuit which may result in a fire and burn down the motorcycle in serious cases.

§CHECKING FOR FUEL LEAKAGE§

- Check fuel tank, fuel cup, fuel hose, and carburetor for leakage.

§CHECKING THE LUBRICATION OF BODY'S VARIOUS MECHANISMS§

- Check the body's pivot points if they have enough lubrication.
(for example, the pivot points on the main stand, the side stand, and the brake lever...etc.).

§CHECKING THE SPARK PLUG§

- Remove the cap of spark plug cable (remove the spark plug using the spark plug wrench in the tool kit).
- Check the electrode if it is dirty or fouled by carbon deposits.
- Remove the carbon deposits on the electrode with steel wire, and clean the spark plug with gasoline, then, wipe dry with a rag.
- Check the electrode, and adjust its gap to 0.6–0.7 mm. (Check it with a feeler gauge)
- Hand tight the spark plug as far as it can go and then tighten it another 1/2–3/4 turns with a wrench.

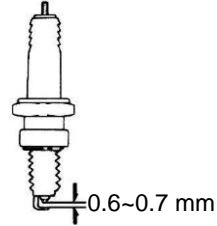

WARNING:

The engine is very hot after running. Pay attention not to get burned.

※Use only spark plugs suitable for the engine specifications of this motorcycle recommended by the manufacturer. (Refer to specifications.)

§CHECKING THE AIR CLEANER §

《DISASSEMBLE PROCEDURE》

1. Remove mounting screws from air cleaner cover.
2. Remove the air cleaner cover, then remove filter element.
3. Take the element out and clean it. (Refer to maintenance schedule.)

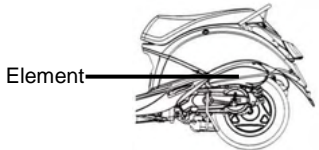

《DISASSEMBLE PROCEDURE》

- Assemble the air cleaner in reverse order of disassemble.

CAUTION:

- Dust deposit is one of the major causes of reducing output horsepower and increasing fuel consumption.
- Change the air cleaner element more frequently to prolong the engine's service life if the motorcycle is driven on dusty roads very often.
- If air cleaner is installed improperly, dust will be absorbed into cylinders, which may cause a premature wear and reducing output power and engine life.
- Be careful not to soak the air cleaner when washing the motorcycle. Otherwise, it will cause engine hard to start.

11. WHEN THERE IS AN ABNORMAL CONDITION OR A TROUBLE

§DIAGNOSIS WHEN ENGINE DOES NOT START §

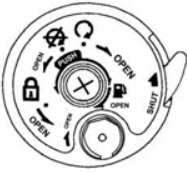

For rear wheel For front wheel

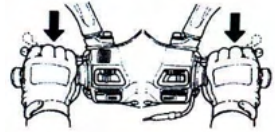

- (1). Has the ignition switch key been turned to the "ON" position?
- (2). Is there enough fuel in the fuel tank?
- (3). Is the rear or front wheel brakes applied when pressing starting button?

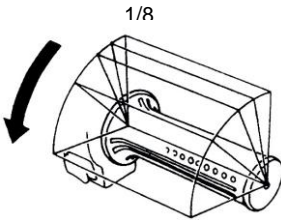

Turn Signal Switch

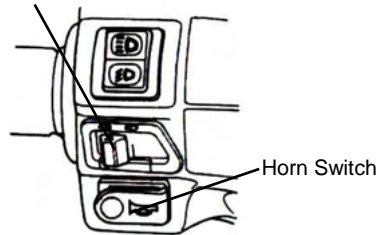

- (4). Do you rotate the throttle valve handle while pressing starting the button?
- (5). Turn the ignition switch key to the "ON" position, and press horn button down, if the horn does not sound, the fuse may have been blown.

【 Have your motorcycle checked by SYM authorized dealer immediately if there are no problems with the above items and engine still can not be started. 】

12. SUGGESTIONS ON ENGINE FUEL

- This motorcycle is designed to use UNLEADED gasoline of Octane No. 90 or higher.
- If the motorcycle is operated in high altitude (where the atmosphere pressure is lower), it is suggested that the air/fuel ratio should be readjusted to maximize the engine performance.

13. TRANSMISSION OIL

- Recommended OIL: SAE 85W-140

14. CAUTIONS FOR RIDING MOTORCYCLE

1. Raise the motorcycle with the main stand, and sit on the seat.
Push the motorcycle forwarding to raise the main parking stand.

 **CAUTION:**

- Never rotate the throttle valve handle at will to increase the engine RPM before driving off.

2. Get on the motorcycle from the left side, and sit on the saddle properly, keep your right feet firmly on the ground to prevent the motorcycle from falling.

 **CAUTION:**

- Apply brake on the rear wheel before driving off.

3. Rotate the throttle valve handle slowly, and then the motorcycle will begin to move.

 **CAUTION:**

- Rapidly rotate the throttle valve handle or release the clutch lever may cause the motorcycle moving forward suddenly and it is very dangerous.
- Make sure the side parking stand is spring back completely before driving off.

【Do not use the brake suddenly and make a sharp turn】

- Rapid braking and sharp turning will cause slip and fall.
- Rapid braking or sharp turning will cause slipping, lateral slipping, or fall especially in rainy days when the road is wet and slippery.

【Drive with extreme caution during rainy days】

- The brake distance in rain day or on wet road will longer than that on a dry road. Therefore, slow down and prepare to apply the brake earlier.
- The throttle valve handle should be released, and the brakes should be properly applied as it is needed while reducing the speed when going down a slope.

15.PERIODICAL MAINTENANCE SCHEDULE

Item	Check Items	Maintenance kilometer	300KM	Every 1000KM	Every 3000KM	Every 6000KM	Every 12000KM	Remarks
		Maintenance Interval	NEW	1 Month	3 Months	6 Months	1 Year	
1	Air cleaner element (Remark)	I	C			R(paper)	R(sponge)	
2	Air cleaner	I			C			
3	Oil filter (Screen)	C				C		
4	Fuel pump filter			Replacement for every 10000KM				
5	Engine oil	R	I	Replacement for every 3000KM				
6	Tire, pressure	I	I					
7	Battery	I	I					
8	Spark plug	I			I		R	
9	Carburetor (idle speed)	I				I		
10	Steering bearing and handles	I			I			
11	Check transmission for leakage	I	I					
12	Check crankcase for leakage	I	I					
13	Transmission oil	R	Replacement for every 5000KM(5 Months)					
14	Drive belt/roller					I	R	
15	Fuel tank switch and lines	I			I			
16	Throttle valve operation and cable	I	I					
17	Engine bolts and nuts	I			I			
18	Cylinder head, cylinder, and piston					I		
19	Exhaust system/cleaning carbon					I		
20	Cam Chain/ignition time	I			I			
21	Valve clearance	I				I		
22	Shock absorbers	I				I		
23	Shock tension rod			Inspection every 10000KM,Replacement every 30000KM				
24	Front/rear suspension	I				I		
25	Main/side stands	I				I/L		
26	Crankcase Blow-by system(PCV)	I			I			
27	Clutch disk					I		
28	Brake mechanism/brake lining (pad)	I	I					
29	Bolts/nuts for each components	I	I					

☆The above maintenance schedule is established by taking the monthly 1000 kilometers as a reference which ever comes first.

Code: I ~ Inspection, cleaning, and adjustment R ~ Replacement
 C ~ Cleaning (replaced if necessary) L ~ Lubrication

Remark: 1. Clean or replace the air cleaner element more often when the motorcycle is operated on dusty roads or in the Heavily- polluted environment.

2. Maintenance should be performed more often if the motorcycle is frequently operated in high speed and after the motorcycle has accumulated a higher mileage.

[Notes in the remarks are used to indicate the applicable models.]

16.SPECIFICATION

Item	Model	FS05W2-EU	FS05W2-NL
	Specification		
Length		1760 ± 20mm	
Width		695 ± 10mm	
Height		1050 ± 20mm	
Wheel base		1250 ± 20mm	
Net Weight		88 ± 4kg	
Type		4- stroke single cylinders engine	
Fuel		UNLEADED (OCTANE 90 OR HIGHER)	
Compression ratio		11.0 ± 0.2:1	
Maximum HP		2.2kw/8000rpm	2.0kw/6000rpm
Maximum torque		3.0 Nm/6000 rpm	3.2 Nm/5500 rpm
Starting methods		electrical starter	
Front shock absorber		TELESCOPE	
Rear shock absorber		UNIT SWING	
Clutch		Centrifugal type	
Transmission		CVT	
Front tire		90/90-10	
Rear tire		90/90-10	
Wheel		Aluminum	
Tire pressure		Front: STD 2.00 kg/cm ² , Rear: STD 2.00kg/cm ² for 1 person, 2.25kg/cm ² for 2 persons	
Front brake		Disk type (Ø 160 mm)	
Rear brake		Drum type (Ø 110 mm)	
Headlight Deep/main beam		12V 35/35W X1	
Position lamps		12V 0.31W X1	
Taillight/stoplight		13.5V 0.47W/0.96W X1	
Front Turn signal light		13.5V 2.2W X2	
Rear Turn signal light		13.5V 2W X2	
Engine oil capacity		0. 8L (0.7L for change)	
Transmission oil capacity		110c.c (100c.c for change)	
Fuel tank capacity		5.2 ± 0.2L	
Fuse		20A*1&15AX2&10AX1	
Spark plug		CR6HSA	
Battery capacity		12V 6Ah	
Air cleaner		Paper type	