



# 1. Contents

---

1. <b>Contents</b> .....	1
2. <b>Before Riding</b> .....	3
3. <b>Serial Number/Labels Location</b> .....	3
4. <b>Safe Riding</b> .....	4
5. <b>Driving</b> .....	5
6. <b>Use Genuine Spare Parts</b> .....	5
7. <b>Parts Location</b> .....	6
Combination instrument .....	9
Ignition switch .....	15
Right handlebar switches .....	17
Left handlebar switches .....	17
Fuel tank cap .....	24
Shopping hook .....	20
Front compartment .....	20
Luggage box/tool kit .....	20
Passenger handlebar/rear carrier .....	21
Top box (LS30W3-EU only) .....	22
Side stand .....	23
Main stand .....	23
Passenger footrest .....	24
Emission control system .....	24
8. <b>How to Start the Engine</b> .....	25
To start the engine .....	25
To stop the engine .....	25
9. <b>How to Ride the Scooter</b> .....	25
Break-in .....	25
Tips of fuel economy .....	26
Throttle control .....	26
Moving off .....	26
Braking .....	27
Anti-lock brake system .....	27
Traction control system .....	28
Park the scooter .....	29
10. <b>Maintenance and Adjustment</b> .....	30
Importance of maintenance .....	30



Routine checks .....	30
Oil level inspection/oil change .....	31
Transmission oil change.....	33
Fuel inspection .....	33
Coolant level inspection/filling .....	33
Coolant change .....	35
Brake system inspection .....	35
Throttle free play inspection .....	37
Tire/tire pressure inspection .....	37
Steering/front fork inspection .....	38
Fuse inspection .....	39
Battery inspection .....	40
Spark plug inspection .....	42
Engine air cleaner/V-belt case air cleaner inspection .....	42
Headlight adjustment .....	43
Rear shock absorber adjustment .....	44
General lubrication .....	44
Vehicle data recorder .....	44
<b>11. Taking Care of Your Scooter</b> .....	<b>45</b>
Washing .....	45
Storage.....	45
<b>12. Trouble Shooting</b> .....	<b>45</b>
Diagnosis when engine does not start .....	45
Overheating .....	46
EFi warning indicator on .....	46
ABS indicator on .....	46
TCS indicator on .....	47
Fuel gauge failure .....	47
Coolant temperature gauge failure .....	47
Exterior lighting burned-out .....	48
<b>13. Periodic Maintenance Schedule</b> .....	<b>49</b>
<b>14. Maintenance Record</b> .....	<b>51</b>
<b>15. Specification</b> .....	<b>52</b>



## 2. Before Riding

This manual describes the correct usage of this scooter including safety riding, simple inspection methods and so on.

For a more comfortable and safety riding, please read this manual carefully.

For your benefit, please ask your **SYM** dealer the operating manual and carefully read the following:

- Correct use of the scooter.
- Pre-delivery inspection and maintenance.

### Thank you very much for your patronage

In order to maximize your scooter's performance, a periodical inspection and maintenance should be completely carried out.

We recommend that after riding your new scooter for the first 300 kilometers, you should take your scooter to the original dealer for an initial inspection, and to have your scooter inspected periodically every 1000 kilometers thereafter.

- In case the scooter's specifications and construction are modified and different from the photos and diagrams on the owner's manual / catalogues, the specifications and construction of the actual scooter shall prevail.

## 3. Serial Number/Labels location

The labels on your scooter provide important safety information. Read the labels thoroughly and do not remove them. Contact your authorized SYM dealer for replacement if any label is missed or damaged.

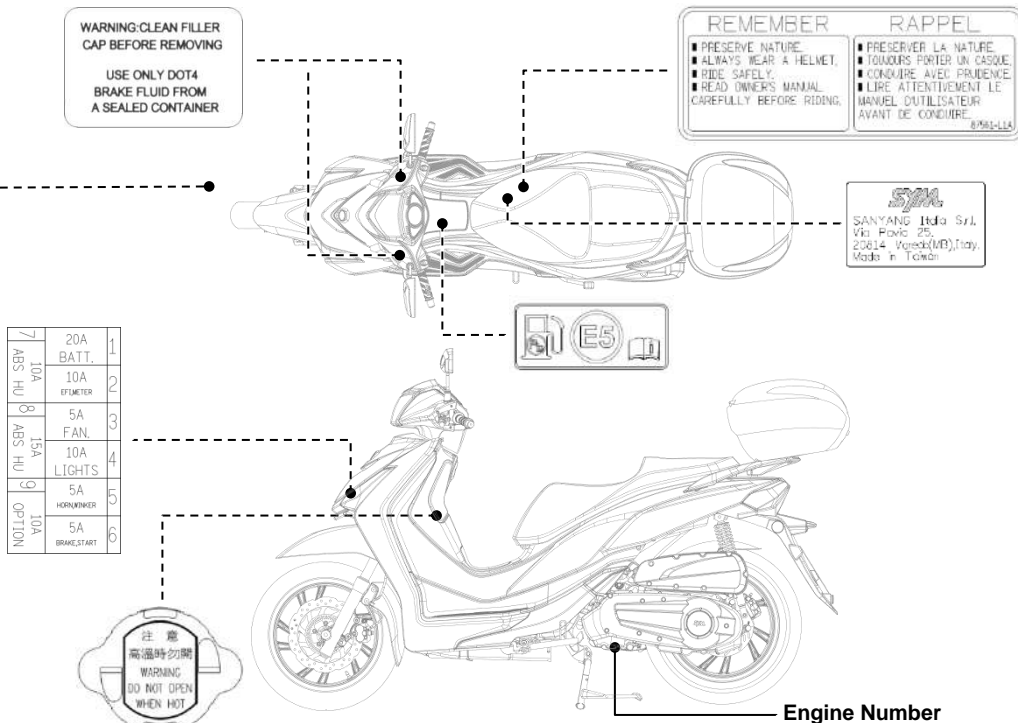



CAUTION		IMPORTANT	
TIRE PRESSURES:		PRESSION DES PNEUMATIQUES:	
FRONT: 25PSI (1.8kgf/cm <sup>2</sup> )		AVANT: 25PSI (1.8kgf/cm <sup>2</sup> )	
REAR: 32PSI (2.3kgf/cm <sup>2</sup> )		ARRIERE: 32PSI (2.3kgf/cm <sup>2</sup> )	
TIRE SIZE:		DIMENSIONS DES PNEUMATIQUES:	
FRONT: 110/70-16 52P		AVANT: 110/70-16 52P	
REAR: 140/70-16 45P		ARRIERE: 140/70-16 45P	

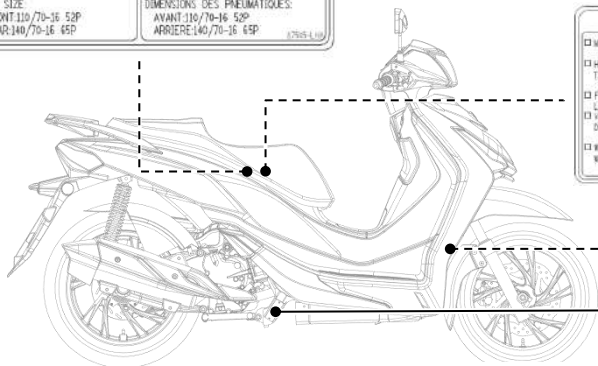

WARNING		ATTENTION	
<input type="checkbox"/> MAX. LOAD IN TRUNK: 10kg <input type="checkbox"/> HEAT OF ENGINE WILL AFFECT THE TEMPERATURE INSIDE THE TRUNK. <input type="checkbox"/> FOR SAFE OPERATION, SEAT MUST LOCK. <input type="checkbox"/> VALVEBELT AND OPEAKABLE, DO NOT PUT IS. <input type="checkbox"/> WATER MAY LEAK INTO TRUNK WHILE WASHING MOTORCYCLE.		<input type="checkbox"/> CHARGE MAX. DANS LE COFFRE A BAGAGES: 10kg <input type="checkbox"/> LA TEMPERATURE A L'INTERIEUR DU COFFRE A BAGAGES EST FONCTION DE LA TEMPERATURE DU MOTOR. <input type="checkbox"/> LA SIELE TOIT EST VERROUILLÉE POUR UNE CONDUITE EN TOUTE SECURITE. <input type="checkbox"/> NE PAS METTRE DE BOUTES TRAGILES OU DE VALEUR DANS LE COFFRE A BAGAGES. <input type="checkbox"/> LORS DU LAVAGE DU VEHICULE, DE L'EAU PEUT PENETREER DANS LE COFFRE A BAGAGES.	

Frame Number  
Vehicle Identification Number

## 4. Safe Riding

It is very important to be relaxed and clothe properly when driving, observe traffic regulations, do not rush, always drive carefully and relaxed.

Usually, most people would ride their newly bought scooter very carefully, but after they became familiar with their scooters, they tended to become reckless which may result in an accident.

### To remind you:

- Please wear a safety helmet, and properly tighten the chin belt when riding a scooter.
- Clothes with open or loose cuffs may be blown by wind and cause the cuffs to get caught on the steering handle and thus affects riding safety.
- So, put on clothes with tight sleeves.
- Hold the steering handle by both hands when riding. Never ride with only one hand.
- Observe the speed limit.
- Wear suitable low-heel shoes.
- **Perform periodical maintenance and inspection in accordance with the schedule.**

### WARNING:

- To avoid getting burned by exhaust pipe when taking a passenger. Make sure your passenger has put his/her feet on the pedals.
- After running, the exhaust pipe is very hot, be careful not to get burned when conducting an inspection or maintenance.
- After running, the exhaust pipe is very hot, select a suitable location to park your scooter to avoid others getting burned by the exhaust pipe.

### CAUTION:

- Modified scooter will affect its structure or performance, and cause poor engine operation or exhaust noise, which will result in shortening the scooter's service life.  
Besides, modification is illegal and does not conform to the original design and specifications. A modified scooter will not be covered by warranty, therefore, do not modify your scooter at will.
- Tire and rim modifications will make it unsafe to ride and may cause severe injury or death.



## 5. Driving

Keep the related parts of your body such as arms, palms, lumbar, and toes relax and ride with the most comfortable posture in order to be able to react quickly whenever it is necessary.

- Rider's posture will greatly affect riding safety. Always keep your body's gravity in the center of the saddle, if your body's gravity is on the rear part of saddle, the front wheel load will be reduced, and this will cause the steering handle shaking. It is dangerous to ride a scooter with an unstable handle.
- It will be much easier to make a turn if rider inclines his body inward when turning. On the other hand, the rider will feel unstable if his body and the scooter do not incline.
- The scooter is hard to control on a bumpy, unlevelled, unpaved road, try to know the road conditions in advance, slow down and use your shoulder's force to control the handle.
- Suggestion: Do not load objects on the front pedals unnecessarily, to avoid affecting the riding safety and the operation of steering handle.



### CAUTION:

- The rider's feeling on the handle is slightly different with a load or without a load.
- Overload may cause the handle to swing and affects the riding safety.
- Therefore, do not overload your scooter.
- Overloading the scooter will cause the scooter to become unstable and hard to maneuver, it may cause serious damage to the tires and rims, as well as it may change the center of gravity, which could result in an accident that could cause injury or death. Do not exceed the maximum authorized load.



### CAUTION:

- Do not place flammable materials such as rags between the body side cover and engine to avoid components damaging by fire.
- Do not load objects on areas not specified for loading to avoid damage.

### SUGGESTION:

To maximize the scooter's performance and prolong its service life:

The first 1000 km is the break-in period for the engine and components.

Avoid rapid acceleration, and do not exceed the recommended engine revolution limits (page 25).

## 6. Use Genuine Spare Parts

In order to maintain the scooter's best performance, each part's quality, material, and machined precision must conform with the design requirements. **"SYM Genuine Spare Parts"** were made from the same high quality materials used for the original scooter. No parts would be sold to the market until they could meet the designed specifications through sophisticated engineering and stringent quality control. Therefore, it is necessary to purchase **"SYM Genuine Spare Parts"** from **"SYM Authorized Dealers or Franchised Dealers"** when replacing spare parts. If you buy cheap, or fake substitute parts from the market, no guarantee can be provided either for the quality or durability. Also, it may result in unexpected troubles and lower the scooter's performance.

- Always use **"SYM Genuine Spare Parts"** to keep your scooters pure blood and to ensure its long service life.

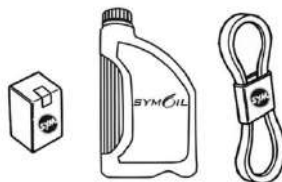



## 7. Parts Location

HD 300 (LS30W2-EU)  
HD 300 (LS30W3-EU)

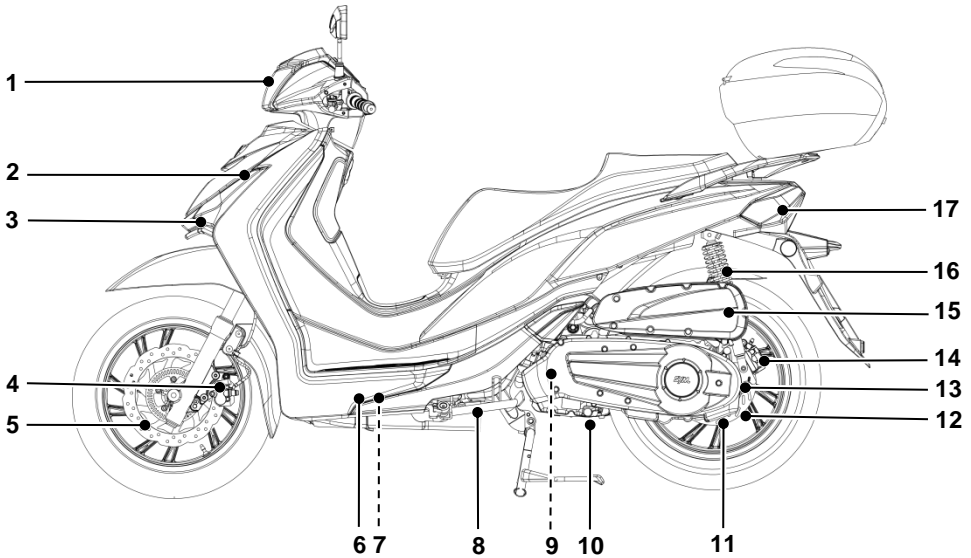

- 1. Headlight
- 2. Position lights
- 3. Front turn indicators
- 4. Front brake caliper
- 5. Front brake disc
- 6. Coolant level inspection window
- 7. Coolant reserve tank
- 8. Side stand
- 9. V-belt case air cleaner

- 10. Oil drain bolt
- 11. Transmission oil drain bolt
- 12. Rear brake disk
- 13. Transmission oil filler bolt
- 14. Rear brake caliper
- 15. Engine air cleaner
- 16. Rear shock absorbers
- 17. Tail/brake lights

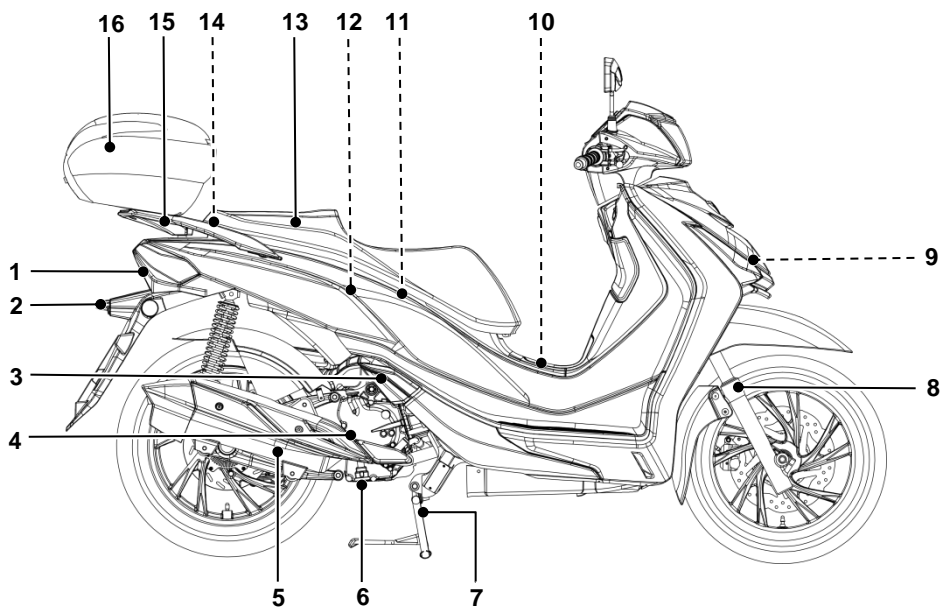

- 1. Rear turn indicators
- 2. License plate light
- 3. Passenger footrests
- 4. Oil filler cap
- 5. Exhaust pipe
- 6. Oil filter screen
- 7. Main stand
- 8. Front fork
- 9. Fuse box

- 10. Fuel tank cap
- 11. Tool kit
- 12. Luggage box
- 13. Seat
- 14. Diagnostic tool connector
- 15. Passenger handlebar
- 16. Top box (LS30W3-EU only)

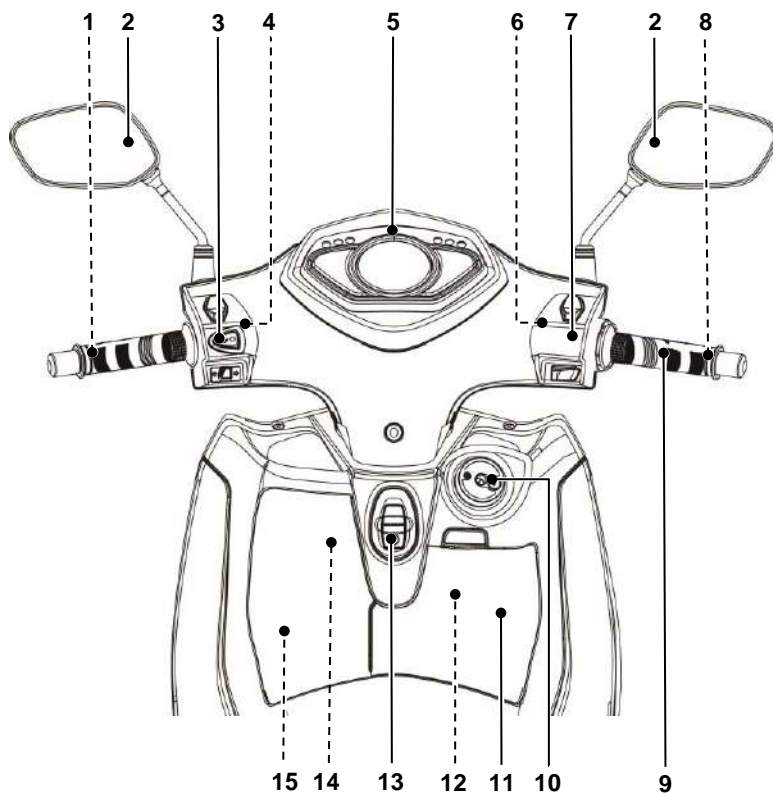

- 1. Rear brake lever
- 2. Rear view mirrors
- 3. Left handlebar switches
- 4. Rear brake fluid reservoir
- 5. Combination instrument
- 6. Front brake fluid reservoir
- 7. Right handlebar switches
- 8. Front brake lever

- 9. Throttle grip
- 10. Ignition switch
- 11. Front compartment
- 12. USB power outlet
- 13. Shopping hook
- 14. Battery
- 15. Radiator cap





## Combination Instrument

HD 300 (LS30W2-EU)

HD 300 (LS30W3-EU)

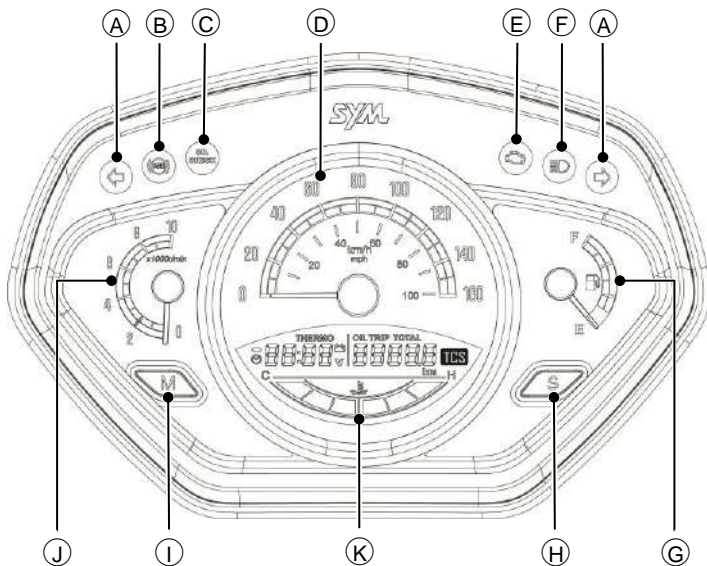

The combination instrument is activated when the ignition switch is turned on. Most indicators are lit up shortly and then go off; all LCD functions are shown for a few seconds for function test, then the whole combination instrument turns to operational mode.

### NOTE :

- Do not wipe plastic components, such as the instrument panel, the headlight, body covers, etc. with solvents, such as gasoline. Wiping plastic components with solvents can cause damage.

### ⚠ WARNING:

- Never operate the instrument buttons while riding the scooter.

### Ⓐ Turn Signal Indicators

The corresponding turn signal indicator light blinks when the turn signal switch is pushed to the right or left.

### Ⓑ ABS Indicator

The ABS (Anti-lock Brake System) indicator goes on when the ignition switch is turned on and goes off shortly after the scooter starts moving. If the ABS is normal, it stays off. If something is wrong with the ABS, the indicator goes on and stays on. When the indicator is on, the ABS does not function, but if the ABS fails, the conventional brake system will still work normally.

### Ⓒ Oil Check Indicator

The oil check indicator shows how long the engine oil is used. The oil check indicator turns on at every 1,000km riding distance according to the oil distance meter (page 13). When this indicator goes on, please



check the oil level in the oil level inspection window (page 31). In oil distance meter mode, quickly press the S button twice to reset the oil check indicator.

### D Speedometer

The speedometer shows the current vehicle speed. The outer hemisphere (a) represents km/h, the inner hemisphere (b) represents mph.

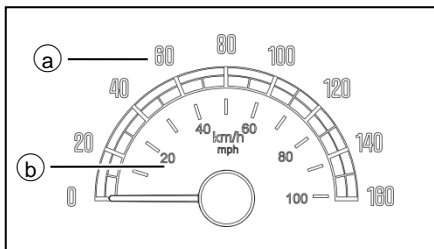

### F EFi Warning Indicator

When turn the ignition switch to “ON” position, the EFi warning indicator remains on initially. It should go off immediately after the engine is running. It displays the condition of the EFi system is working correctly. If there is any problem on the EFi system, the warning indicator remains on all the time. Please contact your SYM authorized dealer if this light goes on all the time.

### F High Beam Indicator

This indicator goes on with high beam headlight is turned on.

### G Fuel Gauge

This fuel gauge shows the fuel level. There are 6 bars in the fuel gauge. If the fuel tank is full, the needle will be in the “F” mark. When the needle is in the red zone (a), go refuel the fuel tank immediately. When the ignition switch is turned on, the fuel gauge needle sweeps across the whole range then return to E position for functional test.

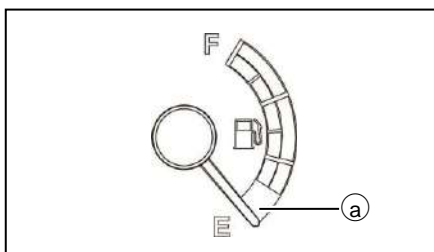

### H S Button

Push this button to reset the trip meter, oil mileage meter and set the clock in the multi-function meter (page 11). Push this button to switch between battery voltage and clock of the multi-function meter.

### I M Button

Press this button to switch meter mode and set the clock of the multi-function meter (page 11).

### J Tachometer

This tachometer shows the engine speed in revolutions per minute (rpm). Do not operate the engine in the red zone. When the ignition switch is turned on, the tachometer needle sweeps across the whole range then return to zero position for functional test.

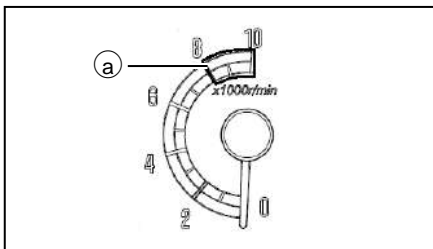

### K Multi-function Meter

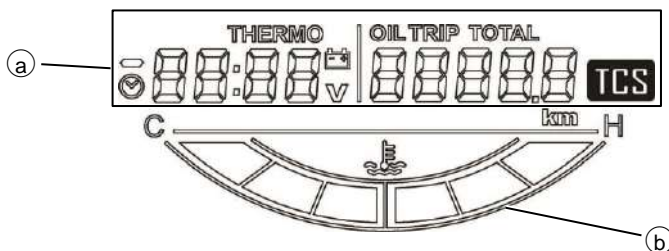

- a. Multi-function display**
- Clock
  - Battery voltage gauge
  - Odometer
  - Trip meter
  - Oil distance meter
  - TCS indicator

- b. Coolant temperature gauge**

### a Multi-function Display

When the ignition switch is turned on, battery voltage will display for approximately 10 seconds. Then the below display mode can be shifted circularly by pushing the S button.

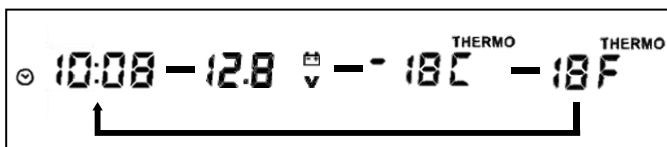

Push M button to switch the below display mode:



**NOTE :**

- The multi-function display always shows the previous selected mode every time you turn the ignition switch on.
- The multi-function display shows in odometer mode after the battery is reconnected.

**Clock**

This clock displays only 24-hour mode.

To set the clock, do the below steps:

- Turn the ignition switch on and wait for approximately 10 seconds until the clock displays.
- Push the M button for more than 2 seconds, the hour display starts blinking. Push the S button to adjust the hours.



- Push the M button. The hour display stops blinking and the minute display starts blinking. Push the S button to adjust the tens place in the minute display.



- Push the M button. The tens place stops blinking and the units display starts blinking. Push the S button to adjust the units place in the minute display.



- Push M button to finish clock setting.

**NOTE :**

- When the battery is disconnected, the clock is reset to 12:00 and starts working again when the battery is reconnected.
- If the clock is idled about 30 seconds while setting, it will exit setting mode automatically and starts working again.
- The clock setting will be finished when the clock is idled about 30 seconds while setting the minute display.
- If the ignition switch is turned off while setting the clock, the clock will exit setting mode when the ignition switch is turned on again.
- The clock works normally by the backup power even the ignition switch is turned off.

**Battery Voltage Gauge**

The battery voltage display shows current battery voltage. It is forced display approximately 10 seconds when the ignition switch is turned on.

- Display range: 8.0 ~ 18.0 V.



### Ambient Temperature Gauge

This gauge shows current air temperature. To check out ambient temperature, push S button in battery voltage mode. This gauge has 2 display modes as below:

- Celsius mode: Display in thermometric scale of Celsius. Push S button to go to Fahrenheit mode.



- Fahrenheit mode: Display in thermometric scale of Fahrenheit.



- Display range: -20 ~ 50°C, -4 ~ 122°F.

### Odometer

This odometer shows the total distance in kilometers the scooter has been ridden. It cannot be reset.



#### NOTE :

- The data is maintained in the combination instrument even when the battery is disconnected.
- When the figures come to 99999, they will return to 0 and the odometer starts working again.
- This odometer only shows in kilometers.

### Trip meter

This trip meter shows the distance in kilometers since it was last reset to zero.



- In trip meter mode, quickly push S button twice to reset trip meter.
- Display range: 0 ~ 999.9 km.

#### NOTE :

- When the figures come to 999.9, they will return to 0 and the trip meter starts working again.
- This trip meter only shows in kilometers.

### Oil distance meter

This meter records how long the engine oil is used. The oil check indicator (page 9) goes on at every 1,000km riding distance according to this oil distance meter. When the oil check indicator goes on, please check the oil level inspection window (page 31).



- In oil distance mode, quickly push S button twice to reset the oil distance meter.
- Display range: 0 ~ 9999.9 km.

**NOTE :**

- If the oil distance meter is not reset, the oil check indicator will go on permanently until it is reset.
- If the oil distance meter is not reset, when the oil distance exceed the maximum limit 9999.9 km, the meter will return to 0 km and continue adding up values. In this condition, the oil check indicator will not go off until it is reset.
- This oil distance meter only shows in kilometers.

**TCS indicator**

This indicator blinks when traction control is intervening. If the traction control system is turned off, this indicator will go on. This indicator goes on whenever the ignition switch is turned off and turned to “On” position; this indicator will not go off until the engine is started. If the light does not go on after turning the ignition switch on, or if the indicator remains on when the engine is started, have the scooter checked by an authorized SYM dealer. Refer to page 28 for more information.

**(b) Coolant Temperature Gauge**

This digital coolant temperature gauge displays the temperature of engine coolant. Normally the first (a) to third (b) sector comes on indicates the engine is working at its operating temperature. The coolant temperature varies with changes in the weather and engine load. If the sixth bar (c) goes on when the scooter is in operation, stop the engine and move the scooter to a safe place, and check the coolant level in the reserve tank and the radiator fan (page 46).

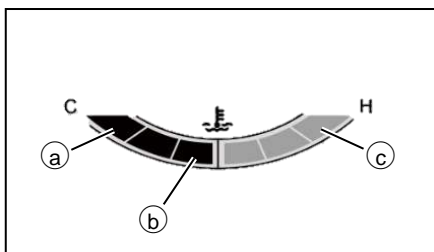

**NOTE :**

- This scooter is not equipped with a high coolant temperature indicator.
- The coolant temperature gauge will not blink when the coolant temperature is too high.
- Please take notice of the coolant temperature gauge when the engine is running.

# Ignition Switch

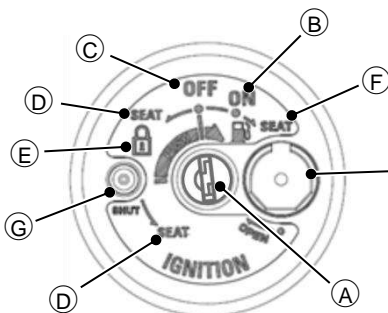

**IGNITION SWITCH**

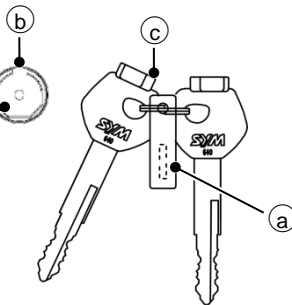

**IGNITION KEYS**

The ignition switch switches the electrical system on/off, locks the handlebar, and opens the seat and the fuel lid. Ignition key can be removed in the “Off” and “Lock” position. This scooter is equipped with 2 ignition keys, carefully store 1 spare key and the serial number tag ①. If you lost any ignition keys, take the serial number tag and contact your authorized SYM dealer.

- Please write down your ignition key serial number: \_\_\_\_\_

## ① Ignition Key Slot

Insert the ignition key into the ignition key slot to operate the ignition switch.

## ② “On” Position **ON**

Engine can be started in this position. Ignition key cannot be removed. Electrical equipment can be used. Headlight comes on in this position. The USB power outlet can be used in this position.

## ③ “Off” Position **OFF**

Engine can be turned off in this position. Electrical circuits will be turned off.

## ④ “Seat Open” Position **SEAT**

The seat can be opened in these positions.

- In “On” position, turn the ignition key clockwise, the ignition key will return to “On” position automatically.
- In “Off” position, turn the ignition key anti-clockwise, the ignition key will return to “On” position automatically.
- In “Lock” position, turn the ignition key anti-clockwise, the ignition key will return to “Lock” position automatically.

## ⑤ “Lock” Position

The handlebar can be locked in this position.

- Turn the ignition key to “Off” position to stop the engine.
- Turn the handlebar fully to the left.
- Push the ignition key anti-clockwise to lock the handlebar.
- The ignition key can be removed in this position.
- To unlock the handlebar, turn the ignition key clockwise to “Off” position.

### **F** “Fuel Lid” Position

The fuel lid can be opened in this position.

- Turn the ignition key to “Off” position.
- Push the ignition key and turn it clockwise to open the fuel lid.
- The ignition key will turn to “Off” position automatically.

### **G** Magnetic Shutter

This magnetic shutter button is designed to close the ignition key slot.

- In “Off ” position, remove the ignition key and push this button to close the slot.
- In “Lock” position, remove the ignition key and push this button to close the slot

### **H** Shutter Opener

This shutter opener is designed to open the magnetic shutter.

Align the projection **c** of the shutter key with the shutter slot **b**, and turn the shutter key clockwise to open.

#### **NOTE :**

- Do not attach too many objects to the ignition key to prevent interfering the workability of the ignition switch.

#### **CAUTION:**

- Never operate the ignition switch key when the scooter is running. Turning the ignition switch to “Off ” position will shut off the electrical system and that may result in a dangerous accident. The ignition switch can only be turned off after the scooter is completely stopped.
- If the ignition switch remains in the “On” position for a prolonged period after the engine is stopped, the battery voltage will be reduced and this may affect engine’s start capability.
- Lock the handlebar before leaving the scooter. Do not leave the key in the ignition switch when leaving the scooter.





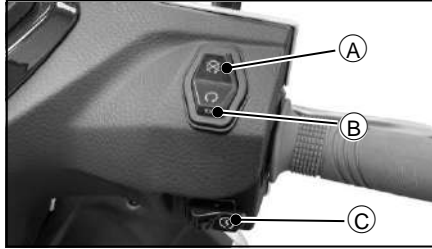

## Right Handlebar Switches



### A Engine Stop Switch

This switch should normally remain in the  position for the scooter to operate. In an emergency, switch to the  position to stop the engine.

#### NOTE :

- Even though the engine stop switch can stop the engine, it does not turn off all the electrical circuits. Normally the engine stop switch should be used to stop the engine.

### B TCS Button

This scooter is equipped with traction control system (TCS). The traction control system can be turned off/on by pushing this button for approximately 3 seconds. Refer to page 28 for more information.

### C Starter Button

This starter button operates the electric starter when the engine is not running. Turn the ignition switch on; push this button while holding the front or rear brake lever to start the engine.

#### NOTE :

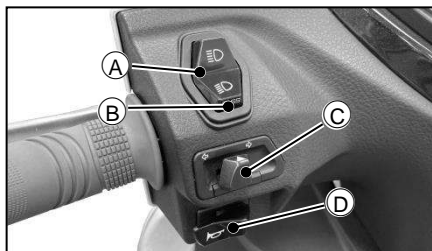

- This scooter is equipped with a permanently lit headlight; the position light, tail light, and the license plate light will light up once the ignition switch is turned on. The headlight will light up when the engine is started. The above mentioned lights cannot be turned off.
- Do not leave the scooter behind too much time after turning the ignition switch on.

## Left Handlebar Switches



### A Dimmer Switch

High and low beam can be selected with this switch. When the headlight is on high beam , the high beam indicator (page 10) goes on.



-  High beam
-  Low beam



## **B** Passing Light Button

When pushing the passing light button **PASS**, the high beam indicator goes on to signal the driver of the vehicle ahead that you are about to pass. The passing light is shut off as soon as the button is released.

## **C** Turn Signal Switch

When the turn signal switch is turned to the left  or right , the corresponding turn signals blink on and off. To stop blinking, push the switch in.

## **D** Horn Button

When the horn button is pushed when the ignition switch is turned on; the horn sounds.

## **Fuel Tank Cap**

- Turn the ignition key to “Fuel Lid” position (page 16) to release the fuel lid **A**.

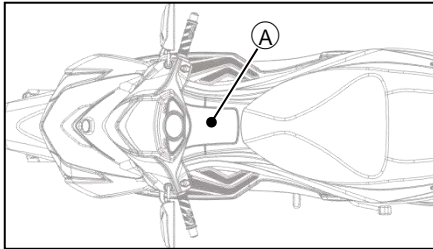

- To open the fuel tank cap **A**, turn it anti-clockwise **a**.
- Put the fuel tank cap on the fuel tank cap seat **B**. Make sure the fuel tank seat is clean.

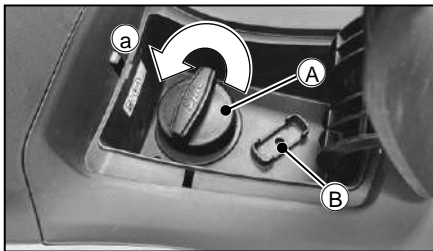

- Fill in the fuel. Do not exceed the bottom of filler neck **A** which is maximum fuel level.

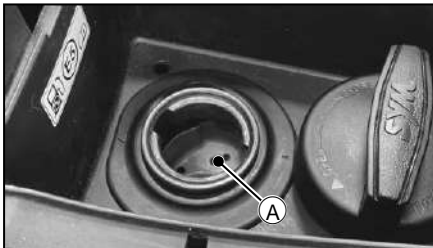

- To close the fuel tank cap, align the two triangle marks **a** on the fuel tank cap and the rubber packing, and turn it clockwise until it is locked.

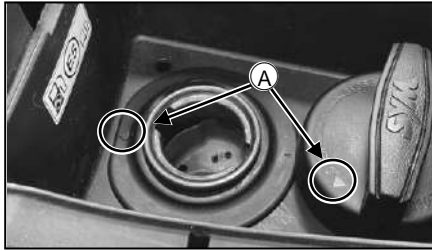

- Press the fuel lid to close it.

**⚠ CAUTION:**

- Gasoline is extremely flammable and can be explosive under certain conditions. Do not smoke and turn the ignition switch off when fueling. Make sure the area is well ventilated and free of any flammable source.
- Never fill the fuel tank to the top. If the tank is filled to the top, heat may cause the fuel to overflow.
- Make sure the fuel tank cap is closed securely after refueling.
- Wipe off the gasoline immediately if it is spilled out on the scooter.

**Fuel Requirement**

- Fuel type: unleaded gasoline only.
- Octane number: Research Octane Number (RON) 92 or higher.
- Gasoline / alcohol blends: as known as gasohol, up to 5%.
- Fuel tank capacity: 10 L.



**⚠ CAUTION:**

- Use only unleaded gasoline to prevent engine damage. Leaded gasoline reduces the capability of the catalytic converter in the exhaust system.
- Use recommended octane number. Using lower octane gasoline will cause engine performance to decrease.
- Never use fuels containing high concentration alcohol.
- Do not use contaminated gasoline.

## Shopping Hook

This scooter is equipped with a shopping hook. Do not attach large luggage to the hook that would hang out from the scooter and interfere the movement of your legs. Push the lower part (A) to open the shopping hook.

- Maximum load: 3 kg.



## Front Compartment

The front compartment is located under the ignition switch. The USB power outlet (A) is in the front compartment. Press down the button (B) to open the compartment cover (C) to get access to the USB power outlet. This power outlet can charge low power consumption devices when the engine is running.

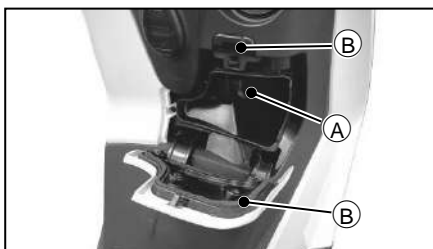

### NOTE :

- Do not use the USB power outlet when the engine is not running.
- Disconnect devices when leaving the scooter or after riding, and close the USB power outlet cap securely to avoid water infiltration.
- Take away valuables before leaving the scooter.

## Luggage Box/Tool Kit

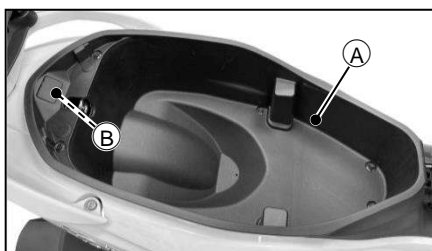

The luggage box (A) is under the seat. Open the seat (page 15) to use the luggage box. Helmets can be stored in the luggage box. Some helmets may not fit in the space due to the size or design. The diagnostic tool connector (B) is located in the rear top of the luggage box.

- Maximum load: 10 kg

The tool kit is stored in the luggage box.

- Slotted/Phillips screwdriver.
- Extension bar.

**NOTE :**

- Do not exceed the maximum weight limit.
- The luggage box may be affected by engine heat. Do not put in valuables, food or objects that are flammable or susceptible to heat damage.
- Take away valuables before leaving the scooter.

## *Passenger Handlebar / Rear Carrier*



The rear carrier is integrated in the passenger handlebar (A); it is designed for installing a top box. To install a top box, follow the below steps.

- Remove the 2 screws (A).
- Pull up carefully to remove the cover (B).
- Remove the clip (C).

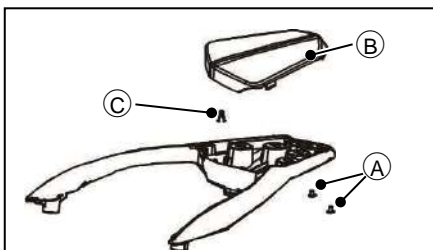

- Install a chosen top box and make sure the top box is mounted securely.

**NOTE :**

- Contact your authorized SYM dealer for more information if you need to install a top box.
- Refer to the installation instructions of the chosen top box before installing.
- If you lack proper experience or doubt your ability, have the top box installed by an authorized SYM dealer.

## Top Box (LS30W3-EU only)

The specified model is equipped with a top box. To open the top box, follow the below steps:

- Insert the ignition key to the top box lock slot, turn it clockwise and push forward to release the top box lid.

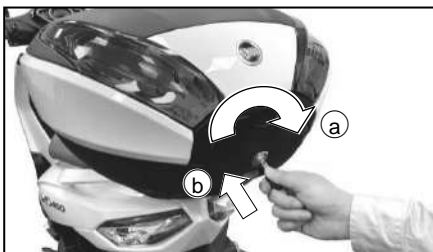

- Open the top box lid. The luggage strip (A) helps fixing luggage in the top box. Push the button (B) to detach the buckle. The ignition key cannot be removed unless you close the top box lid.

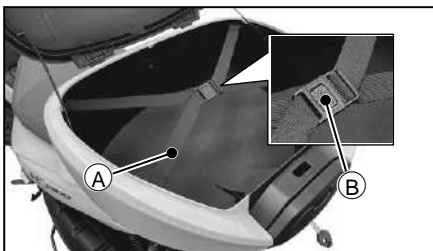

To remove the top box, follow the below steps:

- Insert the ignition key to the lock slot and turn it clockwise.
- Grab the handle (A) and push the button (B) to unmount the top box. Turn the ignition key anti-clockwise and remove the ignition key, then remove the top box carefully.

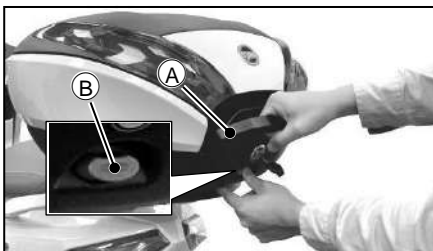

## Side Stand

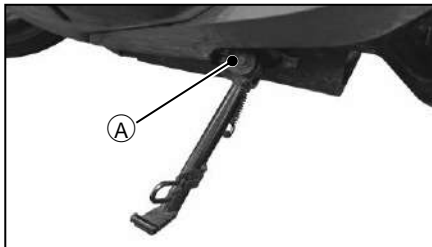

This scooter is equipped with a side stand. The side stand is used to park the scooter. This scooter is equipped with a side stand switch (A). The engine cannot be started when the side stand is kicked down. The engine will be stopped when kicking down the side stand while the engine is running.

### NOTE :

- Turn the handlebar fully to the left when using the side stand.
- Do not sit on the scooter when it is on its side stand.
- If it is necessary to park the scooter on a slope, do not let the front wheel direct the lower side; the side stand may not perform correctly.
- Always kick the side stand fully up before riding.

## Main Stand

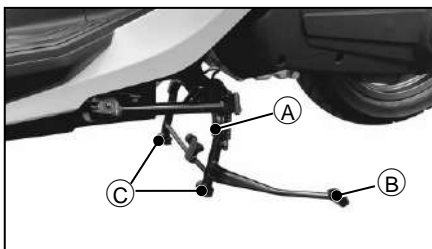

This scooter is equipped with a main stand (A). Use the main stand to park the scooter upright.

- Stand on the left side of the scooter and let down the main stand.
- Hold the left handlebar grip and the left side of the passenger handlebar.
- Press down the tip of the stand (B) with your right foot, make sure the 2 contact points (C) touch the surface firmly.
- Pull up and back.
- Turn the handlebar fully to the left.

### NOTE :

- If it is necessary to park the scooter on a slope, do not let the front wheel direct the lower side; the main stand may not perform correctly and can cause damage to your scooter.

## Passenger Footrest

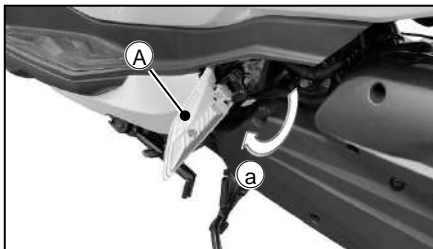

This scooter is equipped with 2 passenger footrests (A). Flip down (a) the footrests for passenger to use.

### NOTE :

- Fold up the passenger footrests when there is no passenger sit on the scooter.

## Emission Control System

### Catalytic Converter

This scooter is equipped with a catalytic converter (A) in the exhaust system. Use only unleaded gasoline. Leaded gasoline can cause unreparable damage to the catalytic converter.

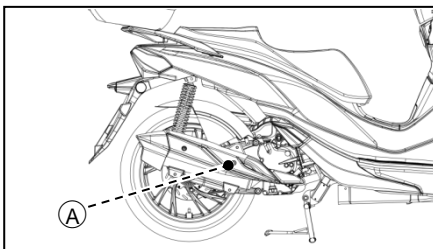

### ⚠ CAUTION:

- Do not park the scooter near possible fire hazards.
- Cautiously choose parking space. Park the scooter in a place where pedestrians or children are not easy to touch the exhaust system.
- Cool down the exhaust system before any maintenance work.
- Do not idle the engine more than several minutes. Long idling can build up heat in the exhaust system.
- If you hear “tick” sound while the exhaust system is cooling down, it derives from the metallic component’s thermal contraction which is normal.

### Canister

This scooter is equipped with a canister (A) to recycle the fuel vapor. Please perform evaporative emission control system inspection in accordance with the periodic maintenance schedule (page 49).



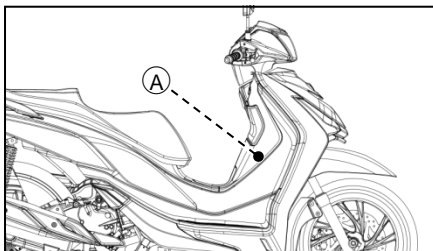

## 8. How to Start the Engine

### *To Start the Engine*

- Make sure the engine stop switch is in the  position.
- Make sure the side stand is up.
- Turn the ignition switch to “ON” position.
- Pull the rear or front brake lever and push the starter button with the completely closed throttle to start the engine.

#### CAUTION:

- Check the oil and the fuel volume before starting the engine.
- Release the starter button immediately after starting the engine.
- If the engine cannot be started after activating the starter 3 ~ 5 seconds, please slightly open the throttle grip then push the starter button can help starting the engine.
- Do not push the starter button for more than 10 seconds to prevent damaging the starter.
- If the engine cannot be started after several attempts, please turn the ignition switch off and wait 10 seconds for the next start.
- Do not push the starter button while the engine is running.
- The exhaust gas is toxic; please start the engine in areas with good ventilation.

### *To Stop the Engine*

- Completely close the throttle.
- Turn the ignition switch to “Off” position.
- Position the scooter on a firm, level surface with side stand / main stand down.
- Lock the handlebar.

#### NOTE :

- This scooter is equipped with a roll-over sensor that can stop the engine automatically when the scooter falls down. To reset the sensor, turn the ignition switch off and turn it on before the engine can be restarted.

## 9. How to Ride the Scooter

### *Break-In*

During the first 1000 km of running, follow the below guidelines to ensure your scooter’s reliability and

performance. Read the following content thoroughly.

- Avoid full throttle starts and rapid acceleration.
- Avoid hard braking.
- Ride the scooter with diverse engine revolution under the below recommended limits.

**0~1000 km: under 5500 rpm.**

1000~ km: the scooter can be operated normally, and have your scooter maintained by an authorized SYM dealer.

- Avoid prolonged low speed riding to prevent parts slippage.
- Ride conservatively.

**⚠ CAUTION:**

- Never run the engine in the red zone of the tachometer during break-in period.
- Do not put excessive load on the engine.
- If any engine problem occurs, have your scooter checked by an authorized SYM dealer.

## Tips of Fuel Economy

Your riding style is one of the major factors of fuel consumption. Please refer to the below tips to reduce fuel consumption:

- Avoid high engine speeds when accelerating.
- Avoid high engine speeds without engine load.
- Turn the ignition switch off rather than keeping it idle for a long period of time.

## Throttle Control

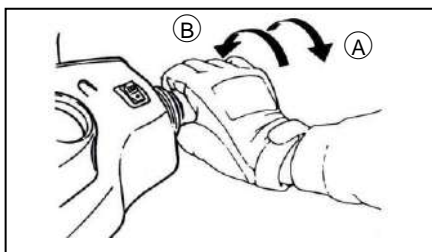

To accelerate, slowly open the throttle ①.

To decelerate, close the throttle ②.

## Moving Off

- Make sure the side stand / main stand is up.
- Make sure the surrounding area is clear.
- Smoothly open the throttle to move off

**⚠ CAUTION:**

- Always open the throttle carefully particularly if you are unfamiliar with the scooter.
- New tires are slippery and may cause loss of control, it is necessary to establish normal tire grip in the break-in period.

## Braking

- Completely close the throttle, the engine will help slowing down the scooter.
- When stopping, always apply both brakes at the same time. Generally speaking, the front brake should be applied a bit more than the rear.
- Never lock the brakes or it will cause the tires to skid. When turning a corner, reduce your speed before getting into the corner.
- Even though this scooter is equipped with ABS, braking during turning a corner may cause wheel slip. It is better to limit and do not apply hard braking force when cornering.
- For emergency braking, focus on applying the brakes as hard as possible.

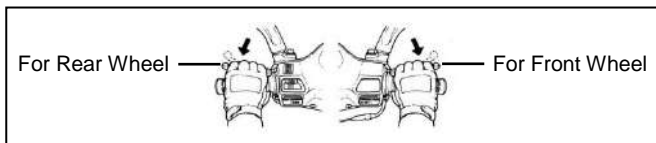

## Anti-lock Brake System (ABS)

ABS is designed to help prevent the wheel from locking up when hard brakes are applied while running straight. The ABS automatically regulates brake force. Intermittently gaining gripping force and braking force helps prevent wheel lock-up and allows stable steering control while stopping. Brake control function is identical to that of a conventional scooter. The brake levers are used for the front and rear brakes.

Although the ABS provides stability while stopping by preventing wheel lock-up, remember the following characteristics:

- ABS cannot compensate for adverse road conditions, misjudgment or improper application of brakes. You must take the same care as with scooters not equipped with ABS.
- ABS is not designed to shorten the braking distance. On loose, uneven or downhill surfaces, the stopping distance of a scooter's with ABS may be longer than that of an equivalent scooter without ABS. Use special caution in such areas.
- ABS will help prevent wheel lock-up during straight-up braking, but it cannot control wheel slip which may be caused by braking during cornering. When turning a corner, it is better to limit braking to the light application of both brakes or not to brake at all. Reduce your speed before you get into the corner.
- When the ABS is activating, you can feel tremble from the front/rear brake lever or both levers.

Be careful not to damage the wheel speed sensors (A) and the wheel speed disks (B); otherwise, improper performance of the ABS will result.

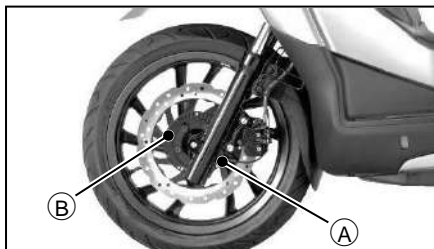

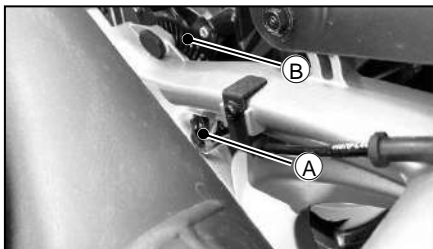

### ABS Indicator

The ABS indicator (page 9) in the combination instrument may go on when the below situation occurs:

- When the engine is started with the main stand raised, turn off the traction control system (page 28) and the throttle is opened to make the rear wheel spins.
- Force the front wheel to off the ground while riding (wheelie).
- When the ABS is subjected by strong electromagnetic interference.
- Either tire is different from the standard size, replace with standard size.
- Either rim is deformed, replace the rim.

If the above mentioned happens, turn the ignition switch off and turn it on, then ride the scooter at more than 5 km/h, the ABS indicator should go off. If the indicator does not go off, have your scooter checked by an authorized SYM dealer.

#### CAUTION:

ABS cannot protect the rider from all possible hazards and is not a substitute for safe riding practices. Be aware of how the ABS operates and its limitations. It is the rider's responsibility to ride at appropriate speeds and manner for weather, road surface and traffic conditions.

## *Traction Control System (TCS)*

This traction control system lowers the engine power output in case of loss of traction in the rear wheel. This system helps maintain traction when accelerating on slippery surfaces, such as wet, muddy or unpaved roads. If sensors detect that the rear wheel is starting to slip, the traction control system intervenes by regulating engine power until traction is recovered.

### TCS Indicator

When the ignition switch is turned on, the traction control system is automatically turned on. The traction control system can be turned off when the ignition switch is turned to "On" position; push and hold the TCS button (page 17) for approximately 3 seconds to turn off the traction control system. To turn on the traction control system, push and hold the TCS button for approximately 3 seconds then the TCS indicator will go off. The traction control system can only be turned off and turned back on when the scooter is stationary.

- TCS indicator goes off: with system turned on and scooter in motion, or when system is detecting wheel speeds.
- TCS indicator goes on: with system turned off by rider, or a malfunction occurs. If the system is turned off before starting the engine (with ignition switch in "On" position), this indicator will remain on after the engine is started.
- TCS indicator flashes: when system is intervening.

**NOTE :**

- The traction control system is automatically turned on whenever the ignition switch is in “On” position, even though the TCS indicator goes on in this condition, the traction control system is turned on.
- When traction control is intervening, you may notice changes in engine response or exhaust sound.
- This traction control system cannot detect sideward slide in the rear wheel while cornering.
- The traction control system does not prevent falls while cornering.
- If the scooter is trapped in mud, sand or other soft surfaces, turn off the traction control system to free the scooter.
- If it is necessary to ride on low grip surfaces, such as gravel pavement, turn off the traction control system and carefully open throttle to allow the scooter to move on.
- Use only standard size tires. The traction control system will not work properly with non-standard size tires.

**Traction Control System Reset**

The traction control system may automatically deactivate (TCS indicator goes on) when the below situation occurs:

- When a wheel speed sensor fault is detected.
- ABS indicator goes on.
- When the EFi warning indicator goes on.

If the above mentioned happens, stop the scooter at a safe place and turn the ignition switch off, and turn it on, then start the engine to reset, the TCS indicator should go off. If the TCS indicator does not go off after resetting, have your scooter checked by an authorized SYM dealer as soon as possible.

**NOTE :**

- Do not turn off the traction control system and rev the engine when the scooter is on its main stand. The traction control system will be disabled and need to be reset.

** CAUTION:**

- Traction control cannot protect the rider from all possible hazards and is not a substitute for safe riding practices. Be aware of how the traction control system operates and its limitations. It is the rider's responsibility to ride at appropriate speeds and manner for weather, road surface and traffic conditions.
- Traction control cannot prevent loss of traction due to excessive speed when entering turns, accelerating abruptly at a sharp slope, or while braking, and cannot prevent front wheel slipping.

***Park the Scooter***

When approaching a parking position:

- Turn on turn indicator in advance, and smoothly close throttle to decrease speed.
- Fully close the throttle and pull brake levers smoothly.

After reaching the parking position:

- Reset the turn signal switch, and turn the ignition switch off to stop the engine.
- To park the scooter, please refer to page 23, “Side Stand” and “Main Stand”.
- Turn the handlebar to the left and lock the handlebar (page 15).

**⚠ CAUTION:**

- Do not turn the ignition switch off while riding.
- The side stand is for uneven ground surface and for short time parking use. Turn the handlebar completely to the left to enhance stability.
- If it is necessary to park the scooter on a slope, do not let the front wheel direct the lower side; the side stand or the parking brake may not perform correctly.
- To avoid heat damage from the exhaust pipe, park the scooter away from pedestrians and children.

## 10. Maintenance and Adjustment

### *Importance of Maintenance*

The maintenance and adjustments mentioned in this chapter must be carried out in accordance with “Routine Checks” and “Periodic Maintenance Schedule” to keep the scooter in well condition and to reduce air pollution. Maintenance is the owner’s responsibility. Be sure to inspect your scooter before every ride and perform the routine checks. The first maintenance is extremely important and must be performed.

**⚠ WARNING:**

- Always follow the inspection, maintenance recommendations, and schedules in this owner’s manual.

SYM cannot warn you of every conceivable hazard that can arise in performance. Only you can decide whether or not you should perform a given task. If you lack proper experience or doubt your ability, please contact your authorized SYM dealer for adjustments, maintenance, and repair work.

### *Routine Checks*

Check the following items each time before you ride.

Items	Key points
Engine oil	Correct oil level.
Transmission oil	No leakage.
Fuel	Sufficient fuel, no leaking.
Brakes	Front and rear brakes are effective.
Tires	Air valve caps are fitted. No puncture. Enough tire pressure.
Handlebar	Any abnormal vibration or is difficult to turn?
Throttle grip	Can be operated smoothly with correct free play.
Rear view mirrors	Clear rear view sight.
Coolant	Coolant level is correct. No leakage.
Electrical equipment	Should work effectively.
Tension of main components	Should be tightened correctly.

## Oil Level Inspection / Oil Change

### Oil Level Inspection:

- If the engine is cold, please warm up the engine for several minutes at idle speed.
- Stop the engine and wait for several minutes to allow the oil to settle.
- Set the scooter upright with the main stand, check the engine oil level through the oil level inspection window **(A)**, the oil level should be between the upper **(a)** and lower **(b)** marks.

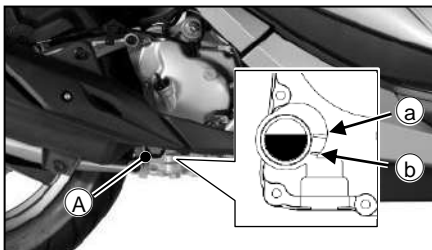

- Top up the oil to the upper mark with the same oil when it is at the lower level. Securely install the oil filler cap **(A)** after adding oil, do not screw it in too much to prevent the O-ring **(B)** from damaging.



- Please check the oil level every 1,000 km.

### **WARNING:**

- Revving the engine before the oil reaches every part can cause engine seizure.
- Engine oil is toxic, dispose engine oil properly. Contact your local authorities for recycling method.

### **NOTE :**

- Oil level will not be correct when checking the oil level with the scooter parked on an uneven ground or immediately after the engine stopped.

### Oil Change:

The oil change should be done by an authorized SYM dealer. The genuine “**SYMOIL**” are designed and recommended for your scooter.

- Please choose oil grade that is equal to (or greater than) SAE 10W-30, API SL. SYM is not responsible for any damage caused by improper oil.
- The first oil change for the scooter is at the first 1,000km, the oil change interval is every 5,000 km from the third oil change (page 49).
- Check the crankcase drain hose **(A)**, drain it if needed.

### Engine oil capacity

Total: 1.4 L

Periodical maintenance: 1.2 L

### Engine oil recommendation

SYMOIL S6800, API SM (synthetic).

### Tightening torque

Engine oil drain bolt (B): 4.0 kgf-m

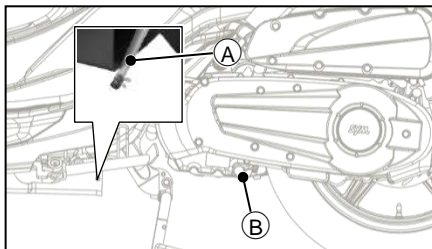

The oil viscosity may need to be changed to accommodate climate conditions in your riding area.

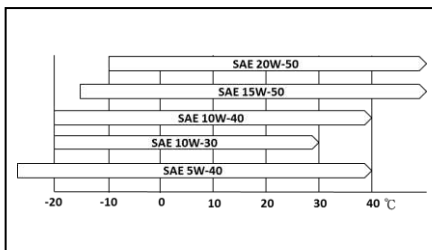

#### NOTE :

- Do not let any foreign object into the crankcase.

### Cleaning of Oil Filter Screen:

The oil filter screen (A) should be cleaned by an authorized SYM dealer. Replace the O-ring (B) with a new one before installing the oil filter screen.

### Tightening torque

Oil filter screen cap (C): 1.5 kgf-m

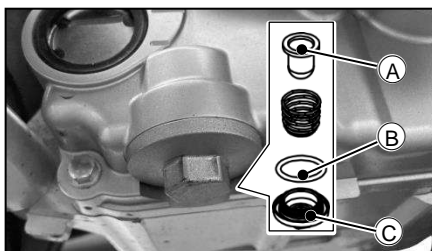



## Transmission Oil Change

The transmission oil should be changed by an authorized SYM dealer. The genuine “**SYMOIL**” are designed and recommended for your scooter.

- Please choose oil grade that is equal to (or greater than) SAE 10W-30. SYM is not responsible for any damage caused by improper oil.
- Replace the washers **(A)** with new ones before installing the drain bolt **(B)** and filler bolt **(C)**.

### Transmission oil capacity

Total: 180 c.c.

Change: 160 c.c.

### Transmission oil recommendation

SYMOIL Gear Oil SAE 10W-30.

### Tightening torque

Transmission oil drain bolt: 1.0 kgf-m

Transmission oil filler bolt: 1.2 kgf-m

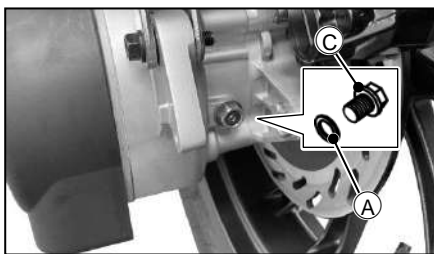
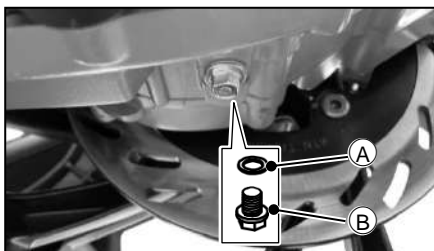

## Fuel Inspection

Make sure the fuel is enough for the trip.

- Turn the ignition switch on, and check the fuel gauge. When the needle is in the red zone (page 10), it shows the fuel remains approximately 2.5 liter (reserve fuel), please fill up the tank immediately.
- Do not add too much fuel to the fuel tank.
- Make sure the fuel tank cap is securely closed.
- Recommended fuel: unleaded 92 (RON) gasoline or greater.

## Coolant Level Inspection / Filling

This scooter is filled with high quality coolant that is designed for the cooling system in the factory. It contains

a 50% solution of ethylene glycol based antifreeze. Position the scooter on level ground and in an upright position. The coolant inspection window **A** is located under the left floor panel. The coolant level must be between the “FULL” **a** and “LOW” **b** marks. Top up the coolant carefully when the level is at the “LOW” mark.

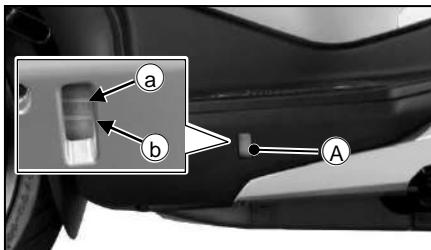

- Pull up the tip of the left floor panel mat **A** to remove it.

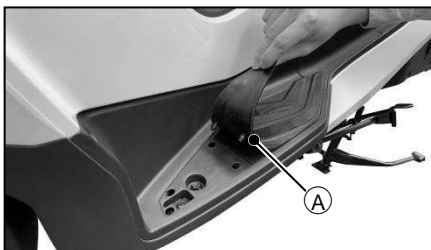

- Wrap a screwdriver that covered with a protective cloth, and insert into the hole to open the maintenance cap **A**.

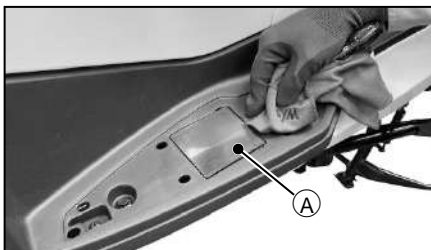

- Open the reserve tank cap **A** to fill in coolant.

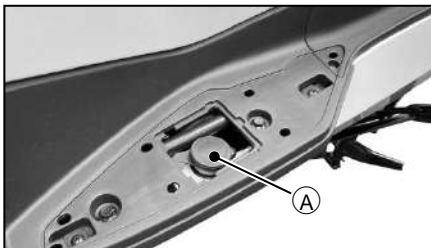

- Reverse the above steps to restore.

**NOTE :**

- You can add distilled water to the coolant reserve tank in an emergency, it must be restored to the correct mixture ratio afterwards.
- If you have to add coolant often, the cooling system may have a leakage problem, have your scooter checked by an authorized SYM dealer.

**⚠ WARNING:**

- Never remove the radiator cap when the engine is hot.

## Coolant Change

Contact an authorized SYM dealer to have the coolant changed.

It is highly recommended to use “**SYM Long Life Coolant**” or equivalent products when filling or changing coolant. “**SYM Long Life Coolant**” is premixed and contains a 50% solution of ethylene glycol based antifreeze, and does not need to be diluted before topping up or changing. “**SYM Long Life Coolant**” is also contains corrosion inhibitor to protect the cooling system.

- Coolant capacity: 1.4 liters.

Please refer to the below list of antifreeze concentration.

Antifreeze concentration	Temperature (°C)	Remark
20%	-8	To ensure antifreeze performance, the original equipped coolant has 50% of antifreeze.
30%	-15	
40%	-24	
50%	-36	

## Brake System Inspection

This scooter is equipped with a disk brake system on the front wheel and the rear wheel. If there is something wrong when applying the brakes, have the brake system checked by an authorized SYM dealer.

**Front / Rear Brake Fluid Level Inspection:**

- Set the scooter upright and set the handlebar to the front.
- Check the brake fluid level in the front / rear brake fluid reservoir (A).
- With the front brake reservoirs held horizontal, the brake fluid level in the inspection window must be above the “MIN” line (a).
- If the brake fluid level is below the lower level, contact your SYM authorized dealer to adjust the fluid level.

**Recommended brake fluid**

DOT 4.

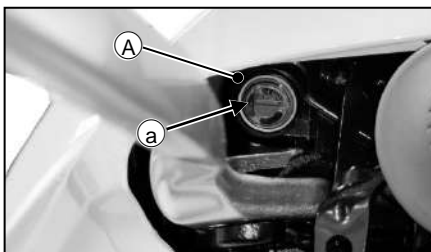

**NOTE :**

- Brake fluid may harm painted surfaces and plastic parts. Spilled fluid must be cleaned up immediately.
- Refill with the same type of brake fluid.

**⚠ WARNING:**

- Use only DOT 4 brake fluid.
- Brake fluid is easy to absorb moisture from the air; any absorbed moisture will reduce the braking efficiency greatly.
- Never let water or dirt enter the reservoirs when refilling.
- Contact an authorized SYM dealer immediately if any brake fluid leakage is found.

**Front / Rear Brake Pad Inspection:**

If you feel something is wrong when applying the brakes, have your scooter checked by an authorized SYM dealer.

- Inspect the front brake pads **(A)** and the rear brake pads **(B)** wear of both disk brake calipers.
- If any groove indicator **(a)** is nearly worn out, have the brake pads replaced by an authorized SYM dealer.

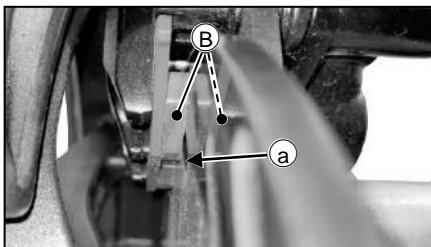



**NOTE :**

- Brake pads must be always replaced as a set.
- New brake pads require a break-in period.

## ***Throttle Free Play Inspection***

- Check that the throttle grip moves smoothly from full open to close.
- Check that there is 5°~ 10° (A) of throttle free play when turning the throttle grip back and forth.
- Have the throttle free play checked by an authorized SYM dealer.

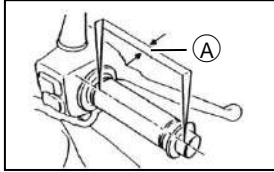

## ***Tire / Tire Pressure Inspection***

- Remove the air valve cap.
- Measure the tire pressure with a tire pressure gauge (A) often and inflates the tires to the recommended tire pressure.

***Recommended air pressure for standard tire MAXXIS M-6135***

Front: 1.8 kgf/cm<sup>2</sup>, 25 psi (110/70-16 52P)

Rear: 2.3 kgf/cm<sup>2</sup>, 32 psi (140/70-16 65P)

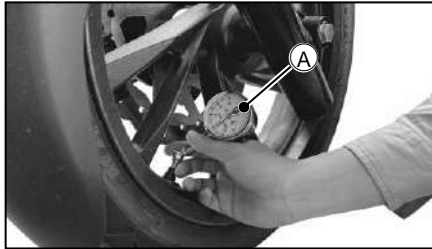

- Visually inspect the tire for cracks and cuts (A) before riding, replace the tires when necessary.

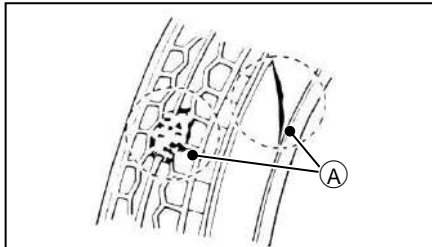



- Measure the depth of the tread with a depth gauge (A), replace the tire that has worn down to the minimum allowable tread depth.

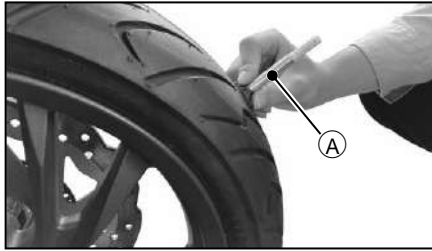

**⚠ WARNING:**

- Insufficient tire tread depth can make the scooter difficult to control.
- Please refer to the local regulations about tire tread depth.
- New tires are slippery and may cause loss of control. Smoothly operate the scooter during break-in period for the new tires.
- Mixing different brands or types of tires can adversely affect handling and may cause fatal injuries.

## ***Steering / Front Fork Inspection***

- Visual inspect that the front fork (A) are damaged or have oil leakage.
- Compress the front fork by pushing down the handlebar (B) to check that the forks can be operated smoothly.
- Check that the steering axle locknut is tightened.
- If any irregularity is found on the handlebar/front fork, contact your authorized SYM dealer.

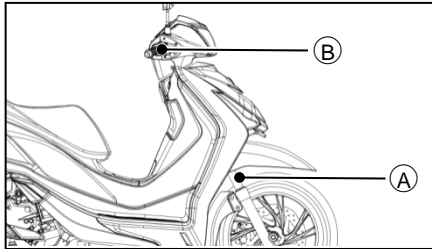



## Fuse Inspection

Fuses are arranged in the fuse box located behind the front top cover. To remove the front top cover, follow the below steps:

- Turn ignition switch off and set the scooter upright.
- Remove the screws (A).

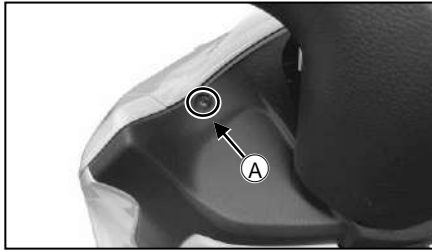
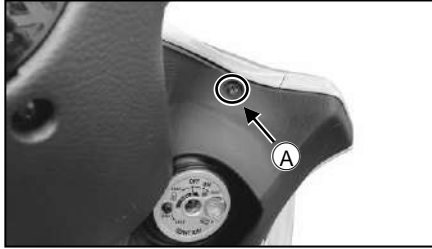

- Carefully remove the front top cover (A). If you found the front top cover is hard to remove, please contact your authorized SYM dealer or have the fuses checked by an authorized SYM dealer to prevent damage.

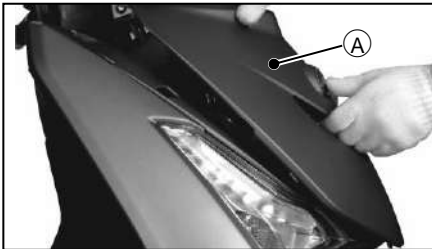

- Open the fuse box (A) to check the fuses.

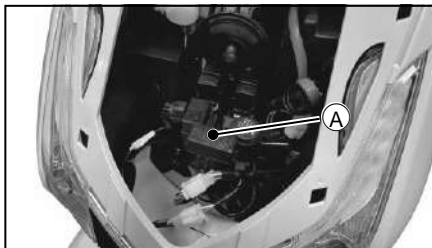

- Reverse the above steps to restore.



If a fuse fails (A), inspect the electrical system to determine the cause, and replace it with a new fuse of proper amperage or have the fuses replaced by an authorized SYM dealer. Do not replace it with any material other than the specified fuse. Have the scooter checked by an authorized SYM dealer if the fuse fails repeatedly.

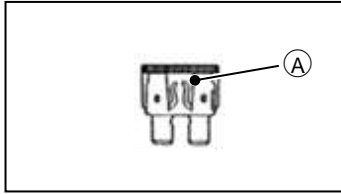

## Battery Inspection

### Battery Inspection

This scooter is equipped with a sealed type battery. There is no need to check the electrolyte level or add distilled water. The battery is located in the battery compartment. To take out the battery, do as the following instructions.

- Open the front compartment (page 20) and remove the screw (A) and remove the battery compartment cover.

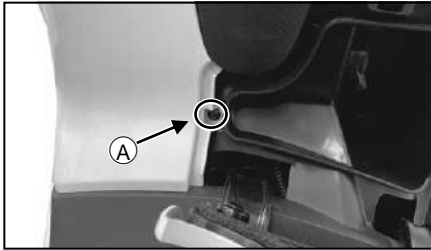

- First disconnect the (-) terminal cable (A) then the (+) terminal (B).
- Remove the 2 screws (A) and remove the battery holder (B).

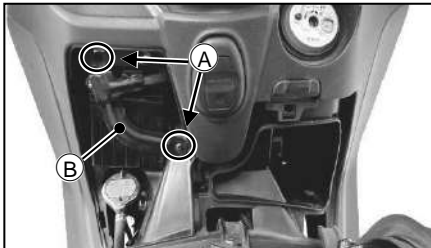

- Carefully take out the battery a bit and disconnect the (-) terminal (A).







- Totally take out the battery and hold it carefully, and disconnect the (+) terminal (A).

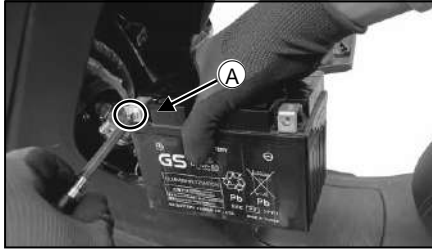

- Clean the terminals (A) by using solution of baking soda and water.

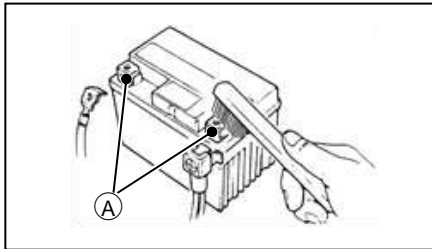

- To install the battery, do in the reverse order of the above instructions. Before installing the battery holder, make sure the (-) terminal wire is in the correct routing (A).

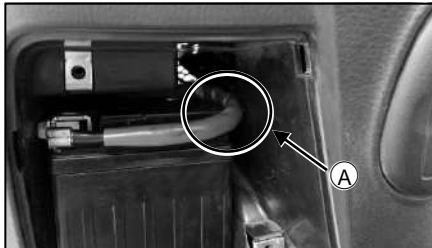

### **Battery type**

GT12A-BS

### **Battery Maintenance**

Keeping the battery fully charged is the owner's responsibility. If you failed to do so, it can cause battery failure and leave you stranded. If you ride the scooter rarely, inspect the battery voltage weekly with a voltmeter. If the voltage drops below 12.0 V, use a suitable motorcycle battery charger to charge the battery. Follow the instructions of the battery charger to charge the battery. Contact your authorized SYM dealer for suitable battery chargers.

### **⚠ WARNING:**

- Electrolyte is poisonous and dangerous since it contains sulfuric acid that can cause severe damage. Avoid any contact with human body or clothing, always protect your eyes when working with a battery.
- A battery produces explosive hydrogen gas; keep sparks, flames away from the battery and provide well ventilation when charging it.
- Keep children away from the battery.



## Spark Plug Inspection

Have the spark plug checked by an authorized SYM dealer. If the electrodes are contaminated with heavy deposits or the insulator is damaged, replace with a new one. Measure the spark plug gap (A) with a wire type feeler gauge. The gap should be within 0.7 ~ 0.8 mm. If adjustment is needed, bend the side electrode (B) carefully.

(B) carefully.

### Recommended spark plug

NGK CR8E

### Spark plug gap

0.7 ~ 0.8 mm

### Tightening torque

1.1 kgf-m

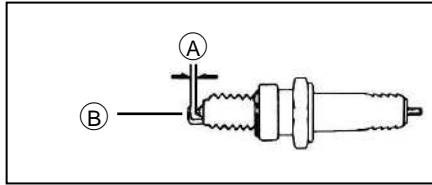

### ⚠ WARNING:

- Beware of the engine heat when inspecting the spark plug.

## Engine Air Cleaner / V-belt Case Air Cleaner Inspection

A dirty engine air cleaner element can reduce the engine performance and increase fuel consumption. Inspect the engine air cleaner by following the below instructions:

- Turn ignition switch off and set the scooter upright.
- Remove the 9 screws (A) and remove the air cleaner cover (B).

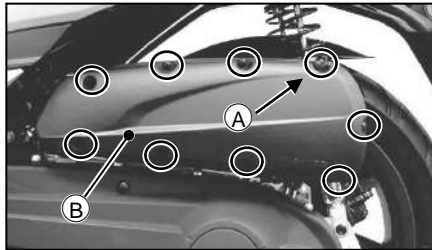

- Remove the air cleaner element (A).

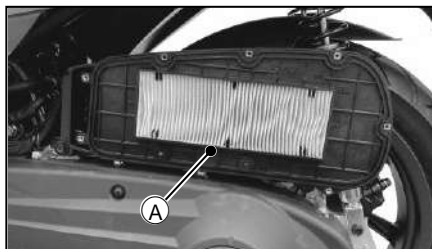



- If the air cleaner element is damaged or too dirty, have it changed by an authorized SYM dealer.
- To install the element, do in the reverse order of the above instructions.

This scooter is equipped with a V-belt case air cleaner element. Inspect the V-belt case air cleaner by following the below instructions:

- Turn ignition switch off and set the scooter upright.
- Remove the 5 bolts (A) and remove the left crankcase outer cover (B).

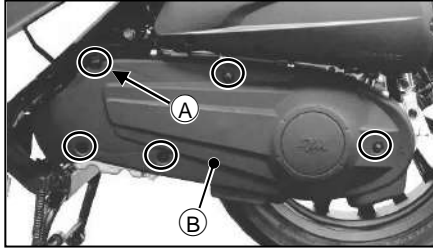

- If the V-belt case air cleaner element (A) is damaged or too dirty, have it changed by an authorized SYM dealer.

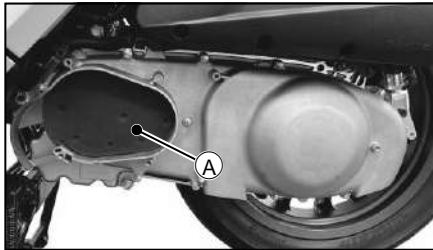

- To install the element, do in the reverse order of the above instructions.

#### **Tightening torque**

Left crankcase outer cover bolt: 1.0 kgf-m

#### **NOTE :**

- Make sure to keep dust or foreign objects from entering the air cleaner during inspection.
- Use SYM genuine air cleaner element to ensure the engine performance.

## **Headlight Adjustment**

The headlight aim can be adjusted for proper alignment. Use a Phillips screwdriver to adjust the low and high beam vertical adjuster (A). Headlight aiming should be performed by an authorized SYM dealer.

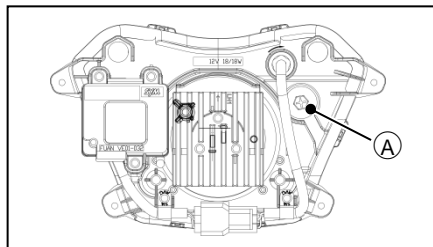



**NOTE :**

- Obey local regulations for headlight aiming adjustment.

## ***Rear Shock Absorber Adjustment***

This scooter is equipped with two 4-position spring preload adjustable rear shock absorbers. The standard position is 2. To adjust the preload setting, follow the below steps.

- Set the scooter upright with the main stand.
- To set the spring harder, turn the adjuster (A) anti-clockwise (a) to increase preload.
- To set the spring softer, turn the adjuster clockwise (b) to decrease preload.
- If it is difficult to turn the adjuster clockwise, keep turning the adjuster anti-clockwise can also set the spring to softer positions.

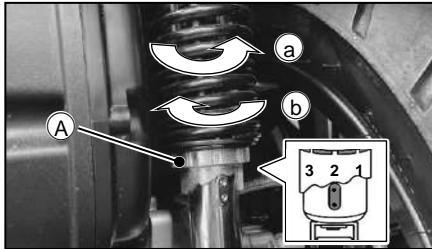

- Contact your authorized SYM dealer for adjustment.

**NOTE :**

- Do not exceed the adjuster's limit.
- Please set the springs harder before the passenger get on the scooter.

## ***General Lubrication***

Lubricate the below parts with either engine oil or general grease in accordance with the "Periodic Maintenance Schedule" (page 49) or whenever the vehicle has been operated under wet or rainy conditions. Clean off rusty spots and wipe off any oil or grease.

- Side stand pivot.
- Main stand pivot.
- Front / rear brake lever pivots.
- Throttle cables.

## ***Vehicle Data Recorder***

This scooter is equipped with an ECU that can record or collect vehicle data for trouble diagnosis and research. The data must be received by a special diagnostic tool when carrying out maintenance or check-up. SYM will not transfer the data to any third party except:

- The owner or user agrees.
- Stipulated by laws.
- In need of lawsuit.
- For research and development, and the data is irrelevant to an individual unit or the owner.



# 11. Taking Care of Your Scooter

## ***Washing***

Fully cool down the engine, muffler, brakes and other high-temperature parts before washing. We suggest you to cover the muffler's exhaust vent.

- Rinse your scooter with cold water from a water hose to remove dirt.
- Mix a neutral detergent that is designed for scooters or automobiles and water in a bucket. Use a sponge to wash your scooter.
- Use low pressure water stream to clean the radiator.
- After washing, rinse your scooter thoroughly with clean water to remove the residue.
- Use an air gun to blow off the water and use a clean soft cloth to dry your scooter.
- Carefully ride your scooter at a slow speed and apply the brakes several times to help drying the brakes.

**NOTE :**

- Do not rinse the radiator with high water pressure.
- After riding in an area where the roads are salted, wash the scooter as soon as possible.
- Specially take care of the matt color plastic parts if they are equipped. Never wax matt color parts.

## ***Storage***

If you plan to store the scooter for a long period, perform the following steps.

- Have the scooter cleaned thoroughly.
- Run the engine for several minutes and shut it off, then drain out the engine oil.
- Add new engine oil.
- Fill up the fuel tank with fuel, add fuel stabilizer if available to prevent the fuel tank from rusting and the fuel from deteriorating.
- Reduce about 20% tire pressure. Have the scooter's two wheels raised off the ground.
- Carefully apply thin oil on all unpainted metal surfaces to prevent rusting.
- Lubricate all cables.
- Remove the battery and have it fully charged. Store it in a cool, dry place and charge it once a month. Make sure the battery is well charged during cold weather.
- Cover plastic bag over the muffler to avoid moisture to get in.
- Cover the whole scooter to protect it from dust and dirt.

**NOTE :**

- Make any necessary repairs before storing the scooter.

**⚠ WARNING:**

- Engine oil is toxic; recycle used oil properly.

# 12. Trouble Shooting

## ***Diagnosis When Engine Does Not Start***

- Is the ignition switch turned to "ON" position?
- Is there enough fuel in the fuel tank?
- Is the rear or front wheel brakes applied when pressing start button?
- Turn the ignition switch to "ON" position, and press the horn button, if the horn does not sound, the fuse



may have been blown.

- Remove the front top cover to check the fuses, if the wire is obvious melted, replacement is needed.
- Is the side stand kicked down?
- When the EFi warning indicator goes on and stays on, contact an authorized SYM dealer for inspection.
- Leaving the scooter unused for a long period of time without adding fuel stabilizer, contact an authorized SYM dealer for inspection.

If the engine still cannot be started after completing the above inspection, contact an authorized SYM dealer for further inspection.

**⚠ WARNING:**

- Replacing fuses can cause wiring to overheat. Use only standard fuses of the correct specifications or have the fuses replaced by an authorized SYM dealer.

## Overheating

The engine is overheating when the below symptom occur:

- The sixth bar of coolant temperature gauge (page 14) goes on.
- Sluggish acceleration.

Pull over safely to the road side and perform the below procedure.

- Turn the ignition switch off to stop the engine then turn the ignition switch on.
- Check the operation of the radiator fan **(A)** then turn off the ignition switch.

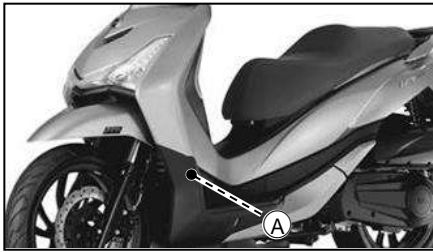

If the fan is not operating, do not start the engine and transport your scooter to an authorized SYM dealer. If the fan is operating, cool down the engine, inspect the cooling system hose and check if there is a leak. If there is a leak, do not start the engine and transport your scooter to an authorized SYM dealer.

**NOTE :**

- Do not deflect airflow through the radiator by installing unauthorized accessories in front of the radiator.

## EFi Warning Indicator On

If this indicator goes on while riding, you may have a serious EFi system problem. Contact your authorized SYM dealer as soon as possible.

## ABS Indicator On

If this indicator goes on in the below conditions, you may have a serious brake system problem.

- The indicator goes on while riding.
- The indicator does not go on when the ignition switch is turned on.
- The indicator does not go off above 5 km/h.

Although the brake system will continue to work without anti-lock function, SYM suggest you to have your scooter checked by an authorized SYM dealer as soon as possible if any of the above symptoms occurs.



## ***TCS Indicator On***

If this indicator goes on in the below conditions, you may have a serious traction control system problem.

- The indicator goes on while riding.
- The indicator does not go on when the ignition switch is turned on.
- The indicator does not go off when the engine is started (without turning off the system.)

Although the scooter can keep normal riding ability without traction control system, SYM suggest you to have your scooter checked by an authorized SYM dealer as soon as possible if any of the above symptoms occurs.

## ***Fuel Gauge Failure***

If the fuel gauge has an error, the needle will be at "E" position, have your scooter checked by an authorized SYM dealer as soon as possible.

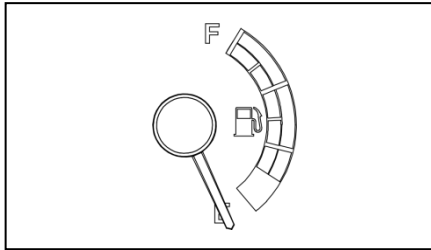

## ***Coolant Temperature Gauge Failure***

If the coolant temperature gauge has an error, all the coolant temperature blinks, have your scooter checked by an authorized SYM dealer as soon as possible.

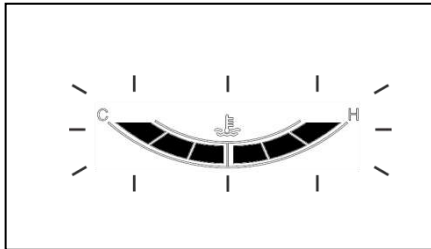



## Exterior Lighting Burned-out

This scooter is equipped with LED exterior lighting except the license plate light and turn indicators. If any LED exterior lighting fails, have your scooter checked by an authorized SYM dealer. If any turn signal indicator bulb is burned-out, have the burned-out bulb replaced by an authorized SYM dealer.

### Turn indicator type

12V 10W x 4

To replace the license plate light, follow the below instructions.

- Turn the ignition switch off and set the scooter upright with the main stand, and cool down the license plate light.
- Remove the screw (A) to remove the license plate light cover (B).

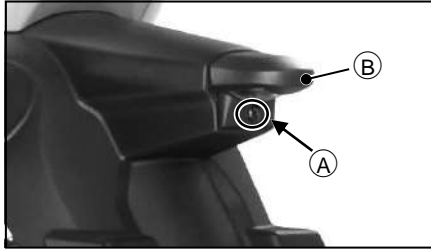

- Carefully pull out the burned-out bulb (A) without turning and replace it with a new one.

### License plate light type

T10, W5W, 12V 5W

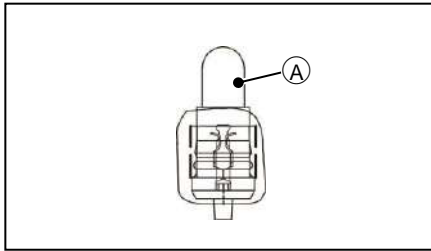

- Reverse the above steps to restore.





# 13. Periodic Maintenance Schedule

	Item	Odometer Reading					Annual service	Page
		1,000km	10,000km	20,000km	30,000km	40,000km		
1	☆ Valve clearance		I	I	I	I		-
2	☆ Engine air cleaner element*		R	R	R	R		42
3	☆ V-belt case air cleaner element*			I/R		I/R		42
4	☆ Engine oil**	R	Second at first 5,000km, every 5,000km thereafter				R	31
5	Engine oil filter screen**	C	Second at first 5,000km, every 5,000km thereafter				C	32
6	Engine oil level	I: every 1,000km						31
7	☆ Transmission oil**	R	R	R	R	R	R	33
8	☆ V-belt*	R: every 20,000km						-
9	☆ Spark plug		I/R	I/R	I/R	I/R		42
10	☆ Idle speed	I	I	I	I	I		-
11	Cooling system <sup>#</sup>		I	I	I	I	I	-
12	Coolant level	I	I	I	I	I		33
13	☆ Coolant, water hoses and O-rings <sup>#</sup>	R: every 3 years					I	-
14	Throttle control system <sup>#</sup>	I	I	I	I	I	I	37
15	☆ CVT system (rollers/shafts/drive pulley cushion)			I/L/R		I/L/R		-
16	Brake system <sup>#</sup>	I	I	I	I	I	I	-
17	Brake operation	I	I	I	I	I	I	-
18	☆ Brake fluid	R: every 2 years or every 30,000km					I	-
19	Brake fluid level	I	I	I	I	I	I	35
20	☆ Brake hoses	R: every 4 years or every 60,000km					I	-
21	Brake pad wear*		I	I	I	I		35
22	Brake light switch operation <sup>#</sup>	I	I	I	I	I	I	-
23	Suspension system <sup>#</sup>		I	I	I	I	I	-
24	Wheels and tires <sup>#</sup>	I	I	I	I	I	I	37
25	Tire pressure <sup>#</sup>	I	I	I	I	I	I	37
26	☆ Wheel bearings		I	I	I	I		-
27	☆ Evaporative emission control system		I	I	I	I	I	-
28	☆ Fuel system <sup>#</sup>	I	I	I	I	I	I	-
29	☆ Fuel hose <sup>#</sup>	I	I	I	I	I	I	-
30	☆ Steering stem bearings		I	L	I	L		-
31	Pivots and cables		L	L	L	L		-



	Item	Odometer Reading					Annual service	Page
		1,000km	10,000km	20,000km	30,000km	40,000km		
32	☆ Electrical system <sup>#</sup>							-
33	☆ Bolts, nuts and fastener condition							-

**I:** Inspect or adjust

**C:** Clean

**R:** Replace

**L:** Lubricate

\*: Service more frequently when riding in severe conditions such as dusty, wet, muddy, high speed, etc.

#: Service annually or at indicated odometer reading intervals, whichever comes first.

☆: Should be performed by an authorized SYM dealer.

- For higher odometer readings, repeat at the frequency shown above.
- If any problem raised about your scooter, please contact your SYM authorized dealer regardless the service schedule.



# 14. Maintenance Record

---

<b>Mileage</b>	<b>Odometer reading</b>	<b>Date</b>	<b>Performed by</b>	<b>Note</b>
1,000 km				
5,000 km				
10,000 km				
15,000 km				
20,000 km				
25,000 km				
30,000 km				
35,000 km				
40,000 km				
45,000 km				
50,000 km				
55,000 km				
60,000 km				
65,000 km				
70,000 km				
75,000 km				
80,000 km				
85,000 km				
90,000 km				
95,000 km				
100,000 km				
105,000 km				
110,000 km				
115,000 km				
120,000 km				
125,000 km				



# 15. Specification

		HD 300 (LS30W2-EU)	HD 300 (LS30W3-EU)
<b>Frame</b>	Overall length	2,220 mm	
	Overall width	770 mm	
	Overall height	1,225 mm	1,250 mm
	Wheel base	1,505 mm	
	Ground clearance	150 mm	
	Caster	27.5°	
	Trail	156.5 mm	
	Min. turning radius	2.5 m	
	Maximum load	180 kg	
	Curb weight	175 kg	179 kg
	Luggage box capacity	38 L	
	Seat height	805 mm	
	Fuel tank capacity	10 L	
	<b>Engine</b>	Type	4T, SOHC, 4V, 1 cylinder, liquid cooled
Compression ratio		10.5:1	
Displacement		278 cm <sup>3</sup>	
Bore × stroke		75 mm × 63 mm	
Max. horse power		25.7 PS @ 7500 rpm	
Max. torque		2.7 kg-m @ 6000 rpm	
Idle speed		1,550 ± 100 rpm	
Starting system		Electric starter	
Fuel system		EFi (fuel injection)	
Fuel		Unleaded 92 (RON) gasoline or greater	
Ignition system		Battery and coil	
Spark plug		NGK CR8E	
Coolant capacity		1.4 L	
<b>Drivetrain</b>	Clutch	Dry, centrifugal	
	Transmission	V-belt CVT	
	Final reduction ratio	8.35	
<b>Lubrication System</b>	Engine oil	SAE 10W30, API SL or greater	
	Lubrication system	Forced, wet sump	
	Engine oil capacity (total)	1.4 L	
	Engine oil capacity (change)	1.2 L	
	Transmission oil	SAE 10W30	
	Transmission oil capacity (total)	180 c.c.	
	Transmission oil capacity (change)	160 c.c.	



		HD 300 (LS30W2-EU)	HD 300 (LS30W3-EU)
<b>Brake System</b>	Front / rear tire	110/70-16 52P, 140/70-16 65P	
	Front / rear tire pressure	1.8 kgf/cm <sup>2</sup> (25 psi), 2.3 kgf/cm <sup>2</sup> (32 psi)	
	Front / rear rim	J16 × MT 3.0, J16 × MT 3.5	
	Rim material	Aluminum alloy	
	Front brake disk	287 mm	
	Rear brake disk	260 mm	
	Front brake caliper	2-piston (ABS)	
	Rear brake caliper	2-piston (ABS)	
	Brake fluid	DOT 4	
<b>Suspension System</b>	Front	Telescopic fork, 35 mm	
	Rear	Dual shock absorber, preload adjustable	
<b>Electrical Equipment</b>	Head light	LED	
	Rear / brake light	LED	
	Turn indicator	12V, 10W × 4	
	License plate light	T10, W5W, 12V 5W	
	Battery	MF, GT12A-BS, 12V 10Ah	

\* Specifications or equipment are subject to change without notice.