



1. Contents

1. Contents	1
2. Before Riding	3
3. Serial Number/Labels Location	3
4. Safe Riding	4
5. Driving	5
6. Use Genuine Spare Parts	5
7. Parts Location	6
Combination instrument	9
Smart key system.....	20
Ignition switch	24
Right handlebar switches	26
Left handlebar switches	26
Front/rear brake lever	27
Windscreen	28
Fuel tank cap	28
Front compartment	30
Luggage box/tool kit/helmet hook	30
Side stand/parking brake	31
Main stand	32
Rear view mirror	32
Passenger footrest	33
8. How to Start the Engine	33
To start the engine	33
To stop the engine	33
9. How to Ride the Scooter	34
Break-in	34
Tips of fuel economy	34
Throttle control	34
Moving off	34
Breaking	35
Anti-lock Brake System	35
Park the scooter	36
10. Maintenance and Adjustment	36
Importance of maintenance	36
Routine checks	37



Oil level inspection / oil change	37
Fuel inspection	39
Coolant level inspection / filling	40
Coolant change	41
Brake system inspection	41
Throttle free play inspection	42
Tire / tire pressure inspection	43
Steering / front fork inspection	44
Fuse inspection	44
Battery inspection	45
Drive chain inspection	46
Spark plug inspection	48
Air cleaner/ V-belt case air cleaner inspection	48
Headlight adjustment	50
Rear shock absorber adjustment	50
General lubrication	51
Vehicle data recorder	51
11. Taking Care of Your Scooter	51
Washing	51
Storage.....	52
12. Trouble Shooting	52
Diagnosis when engine does not start	52
Overheating	52
EFi warning indicator light on	53
ABS indicator light on	53
Low oil pressure indicator on	53
13. Periodic Maintenance Schedule	54
14. Specification	56



2. Before Riding

This manual describes the correct usage of this scooter including safety riding, simple inspection methods and so on.

For a more comfortable and safety riding, please read this manual carefully.

For your benefit, please ask your **SYM** dealer the operating manual and carefully read the following:

- Correct use of the scooter.
- Pre-delivery inspection and maintenance.

Thank you very much for your patronage

In order to maximize your scooter's performance, a periodical inspection and maintenance should be completely carried out.

We recommend that after riding your new scooter for the first 300 kilometers, you should take your scooter to the original dealer for an initial inspection, and to have your scooter inspected periodically every 1000 kilometers thereafter.

- In case the scooter's specifications and construction are modified and different from the photos and diagrams on the owner's manual / catalogues, the specifications and construction of the actual scooter shall prevail.

3. Serial Number/Labels location

The labels on your scooter provide important safety information. Read the labels thoroughly and do not remove them. Contact your authorized SYM dealer for replacement if any label is missed or damaged.

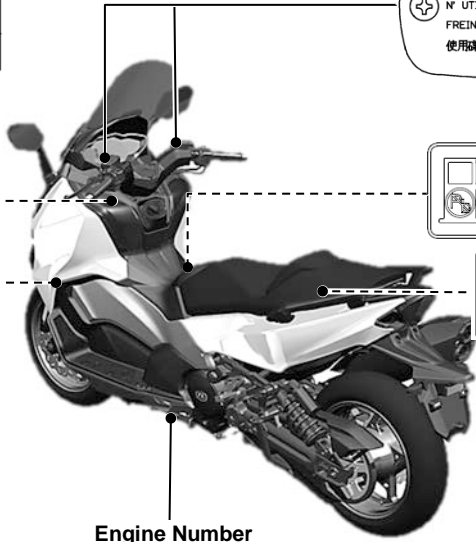
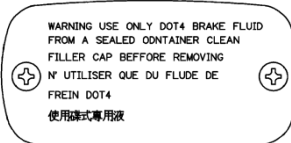

Engine Number



WARNING	ATTENTION
<ul style="list-style-type: none"> ☐ MAX. LOAD IN TRUNK: 10kg. ☐ HEAT OF ENGINE WILL AFFECT THE TEMPERATURE INSIDE THE TRUNK. ☐ FOR SAFE OPERATION, SEAT MUST LOCK. ☐ VALVEBEL AND BREAKABLE, DO NOT PUT IN. ☐ WATER MAY LEAK INTO TRUNK WHILE WASHING MOTORCYCLE. 	<ul style="list-style-type: none"> ☐ CHARGE MAX. DANS LE COFFRE A BAGAGES: 10kg. ☐ LA TEMPERATURE A L'INTERIEUR DU COFFRE A BAGAGES EST FONCTION DE LA TEMPERATURE DU MOTEUR. ☐ LA SELLE DOIT ETRE VERROUILLEE POUR UNE CONDUITE EN TOUTE SECURITE. ☐ NE PAS METRE DES OBJETS FRAGILES OU DE VALEUR DANS LE COFFRE A BAGAGES. ☐ LORS DU LAVAGE DU VEHICULE, DE L'EAU PEUT PENETREER DANS LE COFFRE A BAGAGES.

CAUTION	IMPORTANT
<p>TIRE PRESSURES:PSI(kgf/cm²) DRIVER ONLY: FRONT:32(2.3) REAR:38(2.8)</p> <p>TIRE SIZE: FRONT:120/70R15 58H REAR:160/60R15 67H</p>	<p>PRESSION DES PNEUMATIQUES:PSI(kgf/cm²) CONDUCTEUR UNIQUEMENT: AVANT:32(2.3) ARRIERE:38(2.8)</p> <p>DIMENSIONS DES PNEUMATIQUES: AVANT:120/70R15 58H ARRIERE:160/60R15 67H</p>

REMEMBER	RAPPEL
<ul style="list-style-type: none"> ■ PRESERVE NATURE. ■ ALWAYS WEAR A HELMET. ■ RIDE SAFELY. ■ READ OWNER'S MANUAL CAREFULLY BEFORE RIDING. 	<ul style="list-style-type: none"> ■ PRESERVER LA NATURE. ■ TOUJOURS PORTER UN CASQUE. ■ CONDUIRE AVEC PRUDENCE. ■ LIRE ATTENTIVEMENT LE MANUEL D'UTILISATEUR AVANT DE CONDUIRE.

20A BATT.	1
5A EFI.	2
25A ABS	3
10A LIGHTS	4
5A USB	5
10A COOLING FAN	6

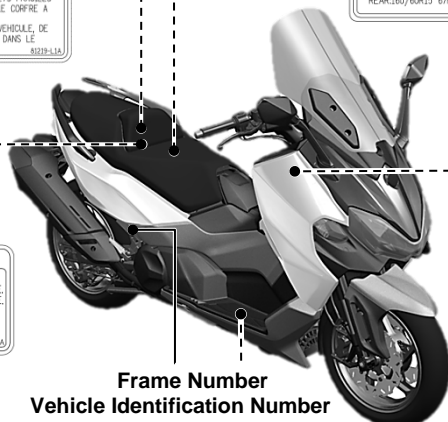

Frame Number
Vehicle Identification Number

4. Safe Riding

It is very important to be relaxed and clothe properly when driving, observe traffic regulations, do not rush, always drive carefully and relaxed. Usually, most people would ride their newly bought scooter very carefully, but after they became familiar with their scooters, they tended to become reckless which may result in an accident.

🔔 To remind you:

- Please wear a safety helmet, and properly tighten the chin belt when riding a scooter.
- Clothes with open or loose cuffs may be blown by wind and cause the cuffs to get caught on the steering handle and thus affects riding safety.
- So, put on clothes with tight sleeves.
- Hold the steering handle by both hands when riding. Never ride with only one hand.
- Observe the speed limit.
- Wear suitable low-heel shoes.
- **Perform periodical maintenance and inspection in accordance with the schedule.**

⚠️ WARNING!!

- To avoid getting burned by exhaust pipe when taking a passenger. Make sure your passenger has put his/her feet on the pedals.
- After running, the exhaust pipe is very hot, be careful not to get burned when conducting an inspection or maintenance.
- After running, the exhaust pipe is very hot, select a suitable location to park your scooter to avoid others getting burned by the exhaust pipe.

⚠️ CAUTION:

- Modified scooter will affect its structure or performance, and cause poor engine operation or exhaust noise, which will result in shortening the scooter's service life. Besides, modification is illegal and does not conform to the original design and specifications. A modified scooter will not be covered by warranty, therefore, do not modify your scooter at will.
- Tire and rim modifications will make it unsafe to ride and may cause severe injury or death.



5. Driving

Keep the related parts of your body such as arms, palms, lumbar, and toes relax and ride with the most comfortable posture in order to be able to react quickly whenever it is necessary.

- Rider's posture will greatly affect riding safety. Always keep your body's gravity in the center of the saddle, if your body's gravity is on the rear part of saddle, the front wheel load will be reduced, and this will cause the steering handle shaking. It is dangerous to ride a scooter with an unstable handle.
- It will be much easier to make a turn if rider inclines his body inward when turning. On the other hand, the rider will feel unstable if his body and the scooter do not incline.
- The scooter is hard to control on a bumpy, unlevelled, unpaved road, try to know the road conditions in advance, slow down and use your shoulder's force to control the handle.
- Suggestion: Do not load objects on the front pedals unnecessarily, to avoid affecting the riding safety and the operation of steering handle.



CAUTION:

- The rider's feeling on the handle is slightly different with a load or without a load.
- Overload may cause the handle to swing and affects the riding safety.
- Therefore, do not overload your scooter.
- Overloading the scooter will cause the scooter to become unstable and hard to maneuver, it may cause serious damage to the tires and rims, as well as it may change the center of gravity, which could result in an accident that could cause injury or death. Do not exceed the maximum authorized load.



CAUTION:

- Do not place flammable materials such as rags between the body side cover and engine to avoid components damaging by fire.
- Do not load objects on areas not specified for loading to avoid damage.

SUGGESTION

To maximize the scooter's performance and prolong its service life:

The first month or first 1000km is the wear- in period for the engine and components.

Avoid rapid acceleration, and do not exceed the recommended engine revolution limits.

6. Use Genuine Spare Parts

In order to maintain the scooter's best performance, each part's quality, material, and machined precision must conform with the design requirements. "**SYM Genuine Spare Parts**" were made from the same high quality materials used for the original scooter. No parts would be sold to the market until they could meet the designed specifications through sophisticated engineering and stringent quality control. Therefore, it is necessary to purchase "**SYM Genuine Spare Parts**" from "**SYM Authorized Dealers or Franchised Dealers**" when replacing spare parts. If you buy cheap, or fake substitute parts from the market, no guarantee can be provided either for the quality or durability. Also, it may result in unexpected troubles and lower the scooter's performance.

- Always use **SYM Genuine Spare Parts** to keep your scooters pure blood and to ensure its long service life.

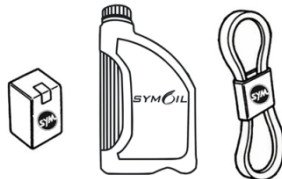



7. Parts Location

MAXSYM TL (TL50W2-EU)
TL 500 (TL50W2-EU)

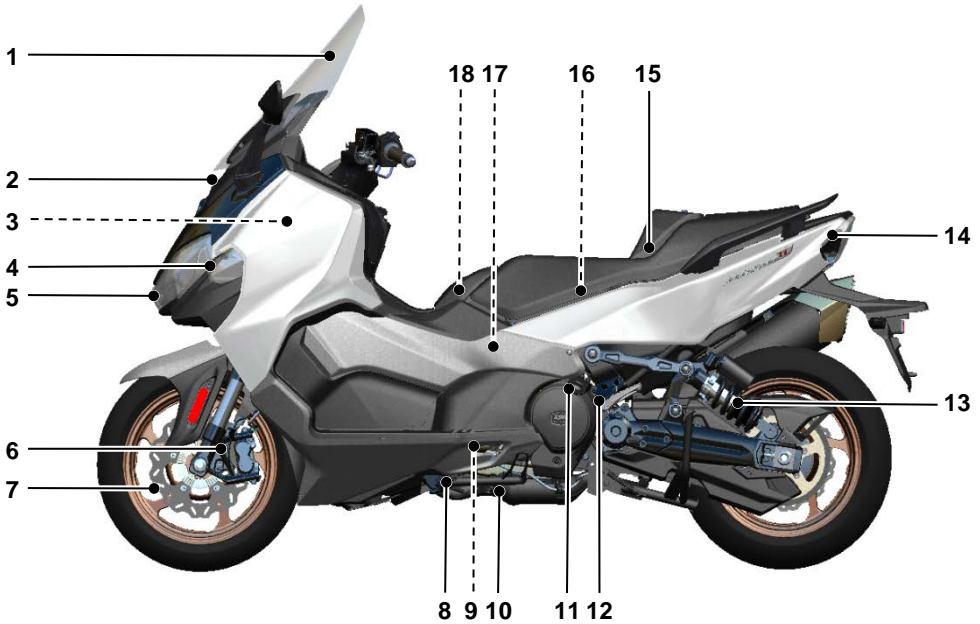

- 1. Windscreen
- 2. Camcorder installation hole
- 3. Engine air cleaner
- 4. Front turn indicators
- 5. Headlight & position light
- 6. Front brake calipers
- 7. Front brake discs
- 8. Side stand
- 9. Oil level inspection window

- 10. Oil drain bolt
- 11. Oil filler cap
- 12. Passenger footrests
- 13. Rear shock absorber
- 14. Tail/brake light
- 15. Seat
- 16. Helmet hook
- 17. V-belt case air cleaner, left
- 18. Fuel tank cap

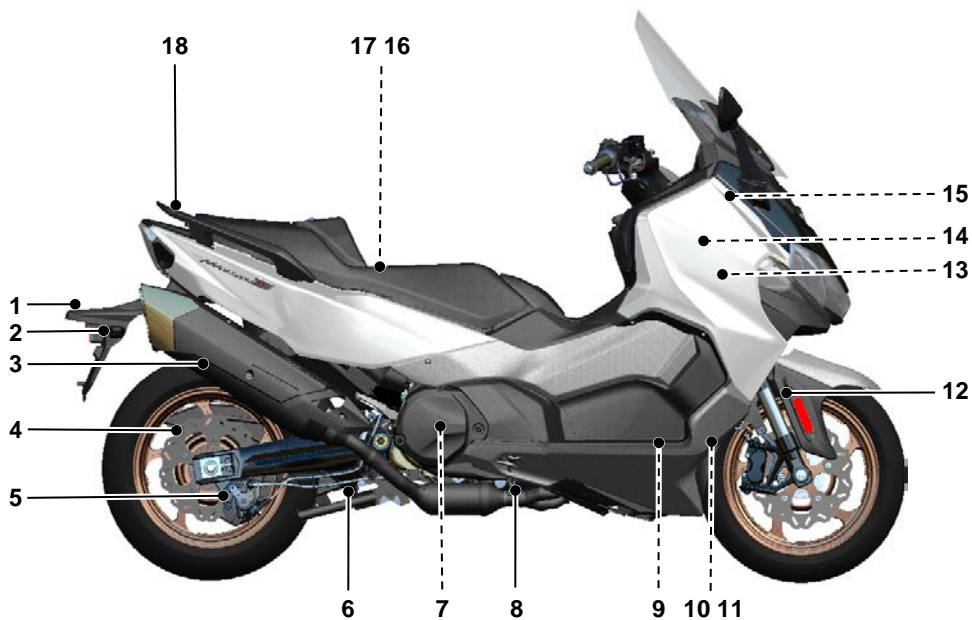

- 1. License plate light
- 2. Rear turn indicators
- 3. Muffler
- 4. Rear brake disk
- 5. Rear/parking brake caliper
- 6. Main stand
- 7. V-belt case air cleaner, right
- 8. Oil Filter screen
- 9. Oil Filter cartridge

- 10. Coolant level inspection window
- 11. Coolant reserve tank
- 12. Front fork
- 13. Battery
- 14. Diagnostic tool connector
- 15. Fuse box
- 16. Tool kit
- 17. Luggage box
- 18. Passenger handlebar

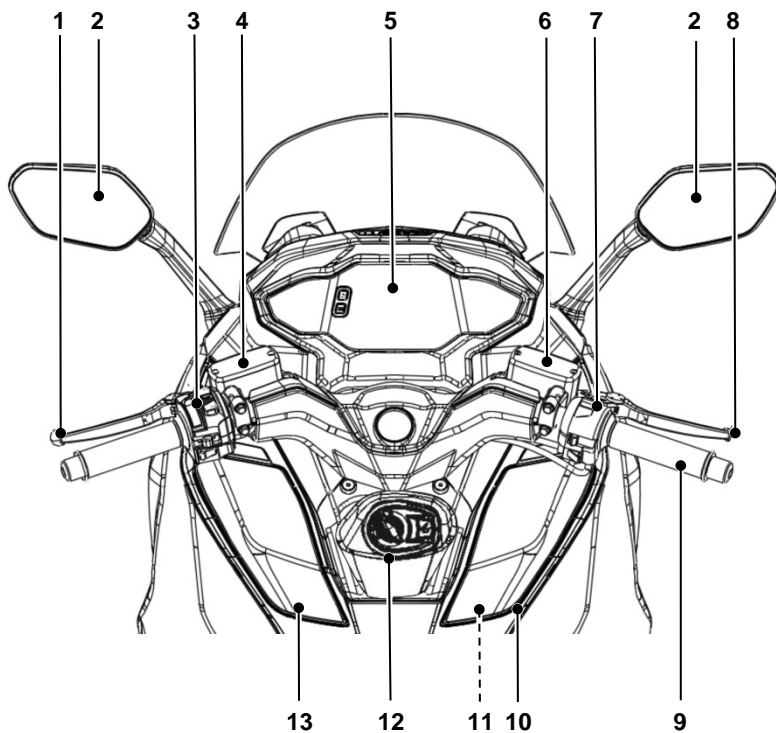

- 1. Rear brake lever
- 2. Rear view mirrors
- 3. Left handlebar switches
- 4. Rear brake fluid reservoir
- 5. Combination instrument
- 6. Front brake fluid reservoir
- 7. Right handlebar switches

- 8. Front brake lever
- 9. Throttle grip
- 10. Right compartment
- 11. USB power outlet
- 12. Ignition switch
- 13. Left compartment



Combination Instrument

MAXSYM TL (TL50W2-EU)

TL 500 (TL50W2-EU)

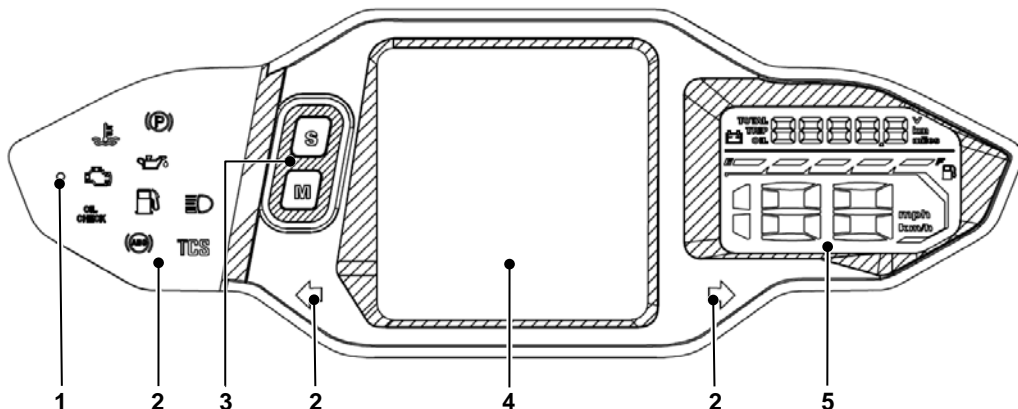

1. Brightness sensor

2. Indicators

3. Setting buttons

4. TFT display

5. Multi-function meter

This instrument is integrated with a brightness sensor; the sensor controls the brightness of the TFT display and the multi-function meter. The combination instrument is activated when the ignition switch is turned on. Most indicators are lit up shortly and the welcome animation appears on the TFT display, and the text and digits in the multi-function meter is lit up as marquee for function test, then the whole combination instrument turns to operational mode.

NOTE :

- Do not wipe plastic components, such as the instrument panel, the headlight, body covers, etc. with solvents, such as gasoline. Wiping plastic components with solvents can damage these components.

⚠ WARNING:

- Never operate the instrument buttons while riding the scooter.



Indicators

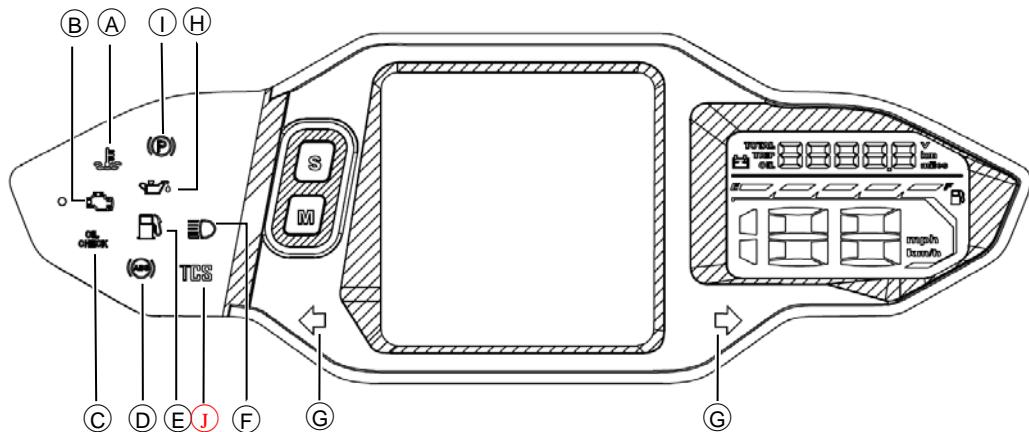

Ⓐ High Coolant Temperature Indicator

This indicator goes on whenever the coolant rises to 115°C. The certain value can be checked in the TFT display. If this indicator comes on when the scooter is in operation, stop the engine and move the scooter to a safe place, and check the coolant level in the reserve tank and the radiator fan.

Ⓑ EFI Warning Indicator

When turn the ignition switch to “ON” position, the EFI warning indicator remains on initially. It should go off immediately after the engine is running. It displays the condition of the EFI system is working correctly. If there is any problem on the EFI system, the warning indicator remains on all the time. Please contact your SYM authorized dealer if this light goes on.

Ⓒ Oil Check Indicator

The oil check indicator shows how long the engine oil is used. The oil check indicator light turns on at every 1,000km riding distance according to the oil distance meter. When this indicator comes on, please check the oil level in the oil level inspection window. In oil meter mode, quickly press the S button twice to reset the oil check indicator.

Ⓓ ABS Indicator

The ABS (Anti-lock Brake System) indicator light goes on when the ignition switch is turned on and goes off shortly after the scooter starts moving. If the ABS is normal, it stays off. If something is wrong with the ABS, the indicator goes on and stays on. When the indicator is on, the ABS does not function, but if the ABS fails, the conventional brake system will still work normally.

Ⓔ Low Fuel Indicator

The low fuel indicator light goes on when the fuel level goes down to 1 steady bar.

Ⓕ High Beam Indicator

This indicator turns on with high beam headlight is turned on.



Ⓒ Turn Signal Indicator

The corresponding turn signal indicator light blinks when the turn signal switch is pushed to the right or left.

Ⓗ Low Oil Pressure Indicator

This indicator goes on whenever the ignition switch is in "On" position without engine running or the oil pressure is dangerously low. It should go off immediately after the engine is running. If this indicator lights up more than 5 seconds, have the scooter checked by an authorized SYM dealer.

Ⓘ Parking Brake Indicator

This scooter is equipped with parking brake. Kick down the side stand to activate this parking brake. This indicator goes on when the side stand is kicked down. The rear wheel will be locked when the parking brake is activated. The engine will be stopped if the side stand is kicked down while the engine is running. This indicator goes off when the side stand is up.

Ⓙ TCS Indicator (if equipped)

The TCS indicator flashes when traction control has engaged. If the traction control system is turned off, this indicator will go on. This indicator comes on whenever the ignition switch is turned off and turned to "On" position; this indicator will not go off until the engine is started. If the indicator does not go on after turning the ignition switch on, or if the indicator remains on when the engine is started, have the scooter checked by an authorized SYM dealer.

Setting Buttons

Ⓐ S Button

Push this button to reset the trip meter, oil mileage meter in the multifunction meter. This button is also used to set the clock in the TFT display.

Ⓑ M Button

Press this button to switch meter mode of the multifunction meter. This button is also used to set the clock in the TFT display.

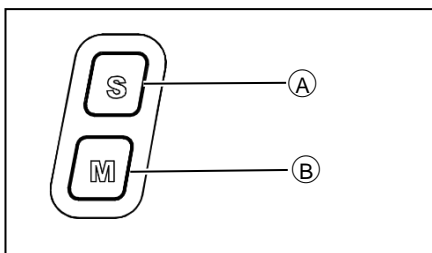

TFT Display Navigation

The up button **Ⓐ**, select button **Ⓑ** and down button **Ⓒ** on the left handlebar switches are used to operate the functions showed in the TFT display.

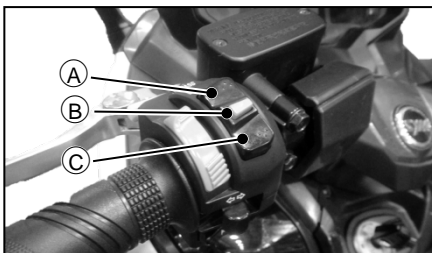

TFT Display

Activation and function test

The combination instrument is activated when the ignition switch is turned on. The welcome animation  appears on the display for seconds and the selected function screen displays after the animation.

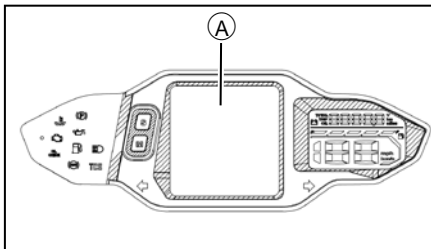

Themes and function screens

This combination instrument is built-in three display themes and each theme contains five function screens. Every function screen in different themes shares the same items.

	RPM	Speedometer	Clock	Trip computer	Vehicle info
Theme 1					
Theme 2					
Theme 3					

Function screen layout

Theme 1 is used for layout description in this section.

RPM

This tachometer shows the engine speed in revolutions per minute (rpm). Do not operate the engine in the red zone. The current fuel consumption level is shown in kilometers/liters (km/l); the light bar varies with the current fuel consumption. Your style of riding can be adapted to the desired fuel consumption. If the scooter is stationary, "0.0" will be shown in the display area.

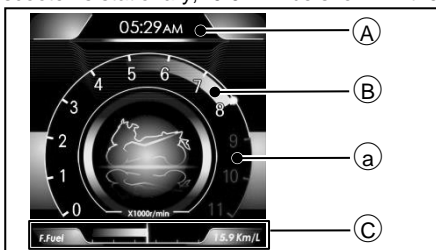

- A. Clock
- B. Tachometer
- C. Current fuel consumption
- a. Red zone

Speedometer

The speedometer shows the current vehicle speed in kilometers/hour (km/h), the reading synchronizes with the multi-function meter's speedometer. The current fuel consumption level is shown in kilometers/liters (km/l); the light bar varies with the current fuel consumption. Your style of riding can be adapted to the desired fuel consumption. If the scooter is stationary, "0.0" will be shown in the display area.

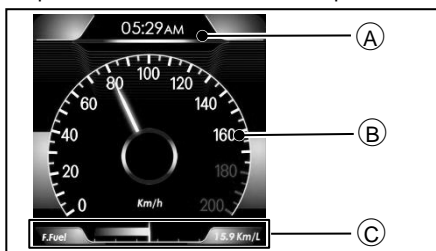

- A. Clock
- B. Speedometer
- C. Current fuel consumption

Clock

This function screen displays one digital and one alternative style. This clock displays only 12-hour mode.



- A. Digital style
- B. Alternative style

To set the clock, do the below steps:

- Turn the ignition switch on, push and hold M button, the hour display starts blinking. Push the S button to adjust the hours.



- Push the M button. The hour display stops blinking and the minute display start blinking. Push the S button to adjust the tens place in the minute display.



Push the M button. The tens place stops blinking and the units display starts blinking. Push the S button to adjust the units place in the minute display.



- Push M button to finish clock setting.

NOTE :

- When the battery is disconnected, the clock is reset to 12:00 AM and starts working again when the battery is reconnected.
- If the clock is idled about 30 seconds while setting, it will exit setting mode automatically and starts working again.
- If the ignition switch is turned off while setting the clock, the clock will exit setting mode when the ignition switch is turned on again.
- The clock works normally by the backup power even the ignition switch is turned off.

Trip computer

This function screen displays four items of the trip computer.

- **Average vehicle speed:** The average vehicle speed is calculated by the total travelled distance and travelled time since the last average vehicle speed reset. The average vehicle speed is reset automatically when the ignition switch is turned off over 30 minutes. This item only displays in km/h.
- **Travelled distance:** The travelled distance is the total driving distance since the last travelled distance reset. The travelled distance is reset automatically when the ignition switch is turned off over 30 minutes. This item only displays in km. Display range: 0~999.9 km. This travelled distance also resets automatically when the values reach the maximum limit 999.9.
- **Travelled time:** The travelled time is the total driving distance since the last travelled time reset. The travelled time is reset automatically when the ignition switch is turned off over 30 minutes.
- **Max RPM:** This function records the maximum engine revolution of this scooter since the last max rpm reset. The max rpm is reset automatically when the ignition switch is turned off over 30 minutes.

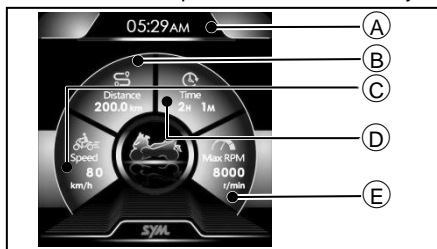

- A. Clock
- B. Average vehicle speed
- C. Travelled distance
- D. Travelled time
- E. Max RPM (maximum engine revolution)

Vehicle information

This function screen displays two items of the vehicle information.

- **Battery voltage gauge:** This gauge shows current battery voltage. The values synchronize with the multi-function meter's battery voltage gauge. Display range: 8.0~16.0V.

NOTE :

- If the battery voltage is below 12.0V when the ignition switch is turned on, and the engine is hard to start or cannot be started, have your scooter checked by an authorized SYM dealer.
- If the battery voltage is below 12.0V or above 15.5V when the engine is running, have your scooter checked by an authorized SYM dealer.

- **Coolant temperature gauge:** It shows current coolant temperature. The high coolant temperature indicator goes on whenever the coolant rises to 115°C (page 10). If the coolant temperature signal is in fault, the stationary symbol “—.” is displayed. Display range: -40 ~ 130°C.

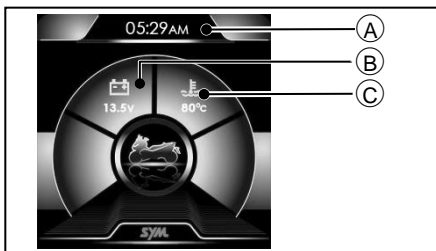

- A. Clock
- B. Battery voltage gauge
- C. Coolant temperature gauge

Function screen select

Push the up or down button to select function screens in any theme. The function screens can be switched in the below order.

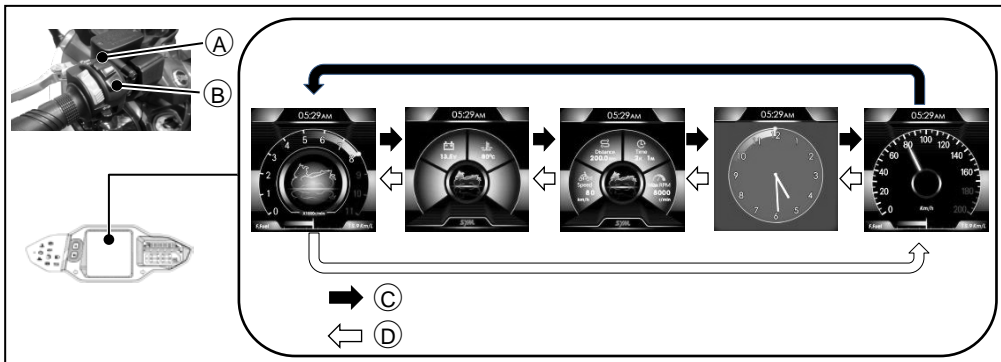

- A. Up button
- B. Down button
- C. Sequence when pushing up button
- D. Sequence when pushing down button

NOTE :

- The TFT display only shows the last selected function screen every time you turn the ignition switch on.
- The function screen select can be operated while riding, do not distract from your current drive.

Theme select

To select the themes, follow the below steps:

- ① In any function screen, push and hold the select button.
- ② The select mode appears, push up or down button to choose a theme.
- ③ Push the select button to finish selecting theme.

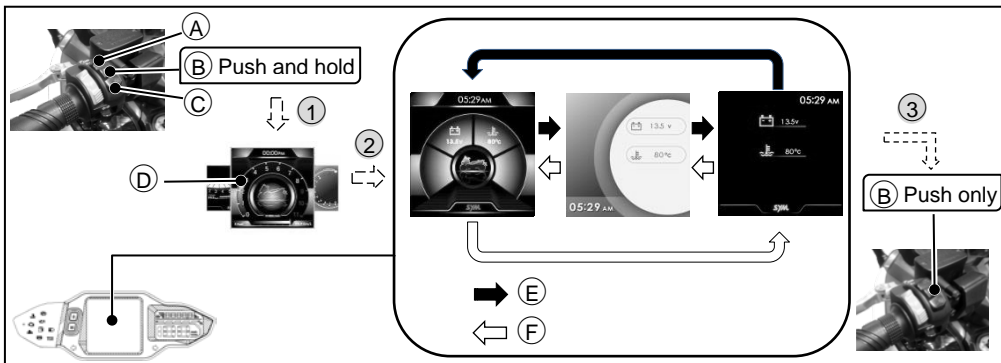

- A. Up button
- B. Select button
- C. Down button
- D. Select mode
- E. Sequence when pushing up button
- F. Sequence when pushing down button

NOTE :

- The select mode only demonstrates rpm function screen.
- The TFT display always shows the previously selected theme/function screen every time you turn the ignition switch on.
- When the battery is reconnected, the TFT display will be reset to the previous selected theme/function screen.
- The theme select can be operated while riding, do not distract from your current drive.

Multi-function Meter

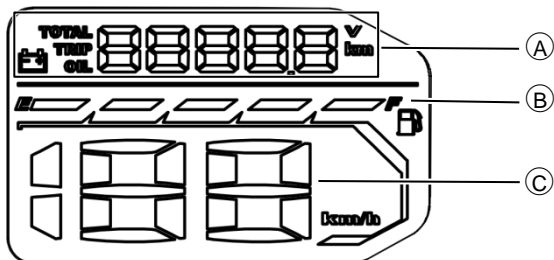

- A. Multi-function display**
- Odometer
 - Trip meter
 - Oil distance meter
 - Battery voltage gauge
- B. Fuel gauge**
- C. Speedometer**

Ⓐ Multi-function display

The below display modes can be shifted circularly by pushing the M button.

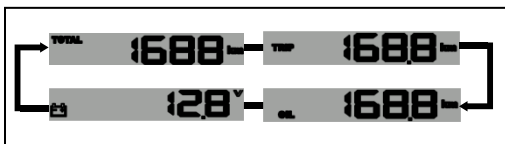

NOTE :

- The multi-function display always shows the previously selected display modes every time you turn the ignition switch on.
- The multi-function display shows in odometer mode after the battery is reconnected.

Odometer

This odometer shows the total distance in kilometers the scooter has been ridden. It cannot be reset.

TOTAL 88888

NOTE :

- The data is maintained in the combination instrument even when the battery is disconnected.
- When the figures come to 99999, they will return to 0 and the odometer starts working again.
- This odometer only shows in kilometers.

Trip meter

This trip meter shows the distance in kilometers since it was last reset to zero.

 **1688**

- In trip meter mode, push and hold S button to reset trip meter.
- Display range: 0~999.9 km.

NOTE :

- When the figures come to 999.9, they will return to 0 and the trip meter starts working again.
- This trip meter only shows in kilometers.

Oil distance meter

This meter records how long the engine oil is used. The oil check indicator goes on at every 1,000km riding distance according to this oil distance meter. When the oil check indicator goes on, please check the oil level in the oil level inspection window.

 **10000**

- In oil distance mode, quickly push S button twice to reset the oil distance meter.
- Display range: 0~9999.9 km.

NOTE :

- If the oil distance meter is not reset, the oil check indicator will go on permanently until it is reset.
- If the oil distance meter is not reset, when the oil distance exceed the maximum limit 9999.9 km, the meter will return to 0 km and continue adding up values. In this condition, the oil check indicator light will not go off until it is reset.
- This oil distance meter only shows in kilometers.

Battery voltage gauge

The battery voltage display shows current battery voltage.

- Display range: 8~16 V.

 **12.8**^v

NOTE :

- If the battery voltage is below 12.0V when the ignition switch is turned on, and the engine is hard to start or cannot be started, have your scooter checked by an authorized SYM dealer.
- If the battery voltage is below 12.0V or above 15.5V when the engine is running, have your scooter checked by an authorized SYM dealer.

B Fuel Gauge

This digital fuel gauge indicates the fuel level. There are 5 bars in the fuel gauge. If the fuel tank is full, all the 5 bars go on ①. The low fuel level indicator (page 10) goes on when there's only the first sector ② remains, go refuel the fuel tank immediately. If the fuel level signal is in fault, all 5 bars blink ③, have your scooter checked by an authorized SYM dealer.

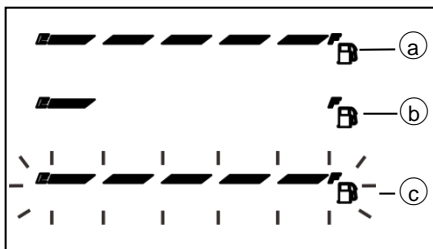

C Speedometer

This digital speedometer displays the current vehicle speed only in km/h.

- Display range: 0~199 km/h

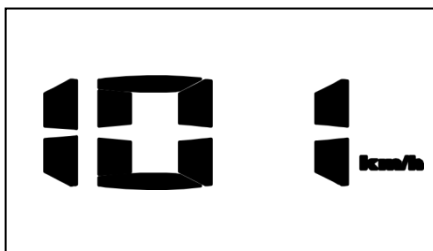

Smart Key System

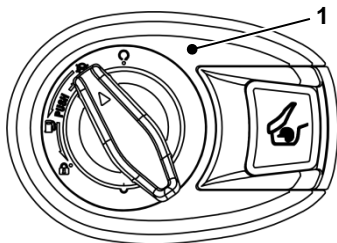

1. Ignition switch

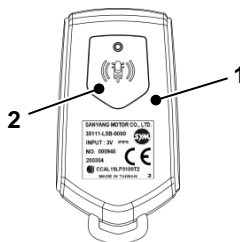

1. Smart key
2. Answer back button

The smart key system enables you to operate the ignition switch without inserting a key into a key slot. The system runs a two-way authentication between the scooter and the smart key to verify it is a registered smart key. There is a function to help you locate the scooter in a parking lot. This smart key system uses low-intensity radio waves. It may affect medical equipment such as a cardiac pacemaker or a cardiac defibrillator; keep these medical devices away from the vehicle-mounted antenna (A). Radio waves transmitted by the antenna may affect the operation of such devices when close by.



NOTE :

- The smart key system may not work in the below situations.
 - The smart key is placed in a location that exposed to strong radio waves or other electromagnetic interference.
 - Nearby facilities that emits strong radio waves such as TV/radio towers, power plants, electric transformers, airports etc.
 - Carrying or using communication devices such as radios or cell phones.
 - The smart key is covered by a metallic object.
- In above situations, move the scooter along with the smart key to another location and press the answer back button to perform the operation.
- The seat open button can only be operated in “On” position.

Operation Range of the Smart Key System

The operating range of the smart key system is approximately 1 meter from the vehicle mounted antenna. The smart key system uses low-intensity radio waves; the operating range may become wider or narrower.

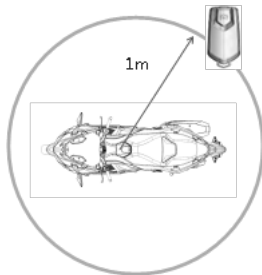

If the smart key is not in the operating range when the ignition switch is in “On” position (page 19), the ignition switch ring will slowly flashes and the beeper on the scooter sounds to alert. If the smart key keeps out of the operating range for more than 1 minute, the ignition switch ring will keep flashing but the beeper stop sounding.

NOTE :

- When the smart key’s battery is discharged, the smart key may not work or the operating range may become very narrow.
- Placing the smart key in the front compartment or the luggage box may block the communication between the smart key and the scooter. If the smart key is locked inside the luggage box, the smart key system may not work properly. Always carry the smart key with you.
- Lock the handlebar and take the smart key with you when leaving the scooter.

⚠ CAUTION:

- Anyone can unlock the ignition switch and start the engine if your smart key is within operating range of your scooter even if you are on the other side of a window, specially take care of your surroundings when closing or leaving the scooter.
- If the ignition switch is in “On” position, the scooter can be operated by anyone who does not have a verified smart key. Lock the handlebar and take the smart key with you when leaving the scooter.

Handling of the Smart Keys and Emergency Keys

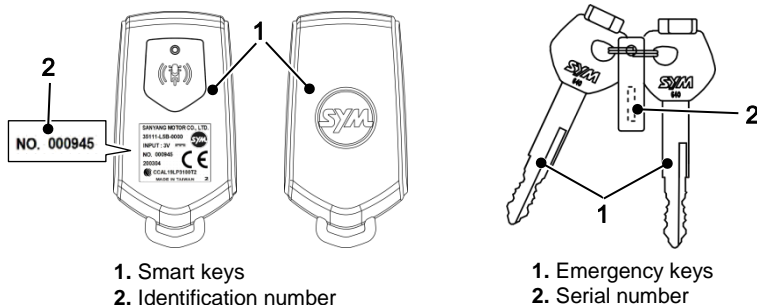

1. Smart keys
2. Identification number

1. Emergency keys
2. Serial number

This scooter is included with 2 smart keys and 2 emergency keys. If the scooter battery or the smart key battery is discharged, you can use the emergency key to open the seat. The seat lock (A) is located in the left

compartment. In addition to the smart key, carry 1 emergency key with you.

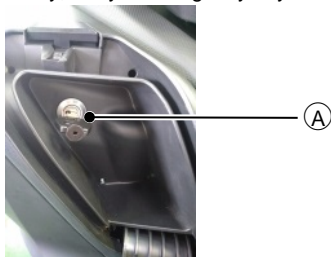

If one of the smart keys is lost, use the spare smart key to operate the ignition switch. If the smart keys are lost, contact your authorized SYM dealer for further process.

NOTE :

- Store the spare smart key securely and do not install a battery before you use it.
- Do not store the smart keys in the front compartments or the luggage box, the smart keys may be damaged by vibration or engine heat.
- Do not drop, bend or hit the smart key.
- Do not put heavy items or too much stress on the smart key.
- Keep the smart keys away from water or other liquids.
- Keep the smart keys away from strong magnetic fields.
- Keep the smart keys away from medical equipment.
- Do not expose the smart keys to sunlight, high temperature or high humidity.
- Do not attempt to modify the smart keys.
- Do not allow chemicals such as oil or fuel into the smart keys to prevent the smart keys from discolored or damaged.

CAUTION:

- Keep the primary smart key with you securely and always beware of the smart key battery status.

Smart Key

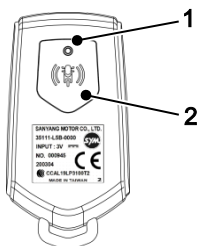

1. Smart key indicator
2. Answer back button

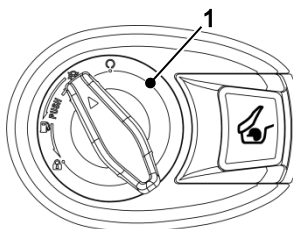

1. Ignition switch ring

This smart key system is equipped with answer back function, it helps you to find the position of your scooter. Push the answer back button to operate this function remotely, the smart key indicator blinks in green and the beeper on the scooter will sound 3 times; the ignition switch ring also flashes 3 times.

If the smart key indicator goes on in red when pushing the answer back button, it shows the battery is discharged, follow the below steps to replace the battery:

- Wrap a coin or a flat head screwdriver that covered with a protective cloth, and insert into the slit (A) and carefully remove the upper case (B).

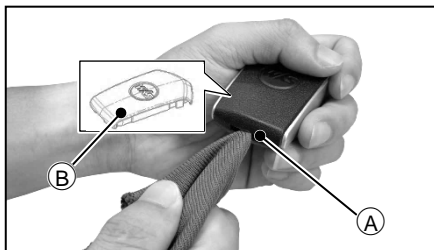

- Remove the inner cover (A) and replace the old battery with a new one; face the positive terminal side up.

Battery type

CR2032

- Reverse the above steps to install, make sure the ring (B) is correctly mounted and do not damage the rubber seal (C).

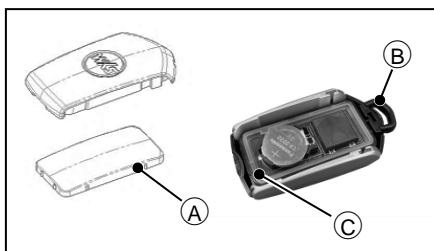

NOTE :

- Do not touch the chips or the circuit board to avoid problems.
- If you lack proper experience or doubt your ability, have the battery changed by your authorized SYM dealer.

Declaration of Conformity

This smart key system complies with the Radio Equipment Directive (2014/53/EU).

Ignition Switch

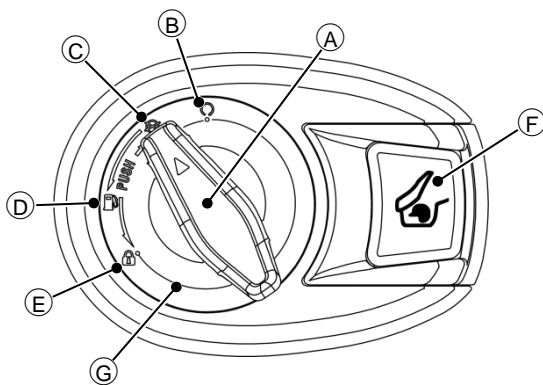

A Ignition Switch Knob

Push or turn the knob to operate the ignition switch. This ignition switch knob can be turned when a verified smart key is in operating range.

B “On” Position

Engine can be started in this position. Electrical equipment can be used. When the ignition switch knob is in “Off” position, quickly push the knob once and turn it clockwise to set the ignition switch to “On” position. The position lights and the ignition switch ring go on in this position. The USB power outlet can be used in this position. If the smart key is not in the operating range when the ignition switch is in “On” position, the beeper on the scooter will sound to alert.

C “Off” Position

Engine can be turned off in this position. Electrical circuits will be turned off. The ignition switch ring goes off in this position. If you push the ignition switch knob without turning it, the ignition switch ring will go on for 4 seconds then go off with a beep sound.

D “Fuel Tank Cap” Position

The fuel tank cap can be opened in this position.

- Turn the ignition switch knob to “Off” position.
- Push and turn the ignition switch knob anti-clockwise to open the fuel tank cap.
- The ignition switch knob will return to “Off” position automatically.

E “Lock” Position

The handlebar can be locked in this position.

- Turn the ignition switch knob to “Off” position.
- Turn the handlebar fully to the left.
- Push and turn the ignition switch knob anti-clockwise to this position.
- To unlock the handlebar, push and turn the ignition switch knob clockwise to “Off” position.

F Seat Open Button

This seat open button is designed to open the seat.

- Turn the ignition switch knob to “On” position.
- Push this button to open the seat.

G Ignition Switch Ring

The ignition switch ring only goes on in the below conditions when a verified smart key is in operating range.

- The ignition switch knob is pushed in “Off” position.
- The ignition switch is in “On” position.
- The ignition switch ring slowly flashes when you are using the answer back function.
- When the ignition switch is in “On” position, the ignition switch ring slowly flashes when the smart key is out of the operating range.

NOTE :

- The seat open button can only be operated in “On” position.

CAUTION:



- Never operate the ignition switch key when the scooter is running. Turning the ignition switch to “Off ” position, will shut off the electrical system and that may result in a dangerous accident. The ignition switch can only be turned off after the scooter is completely stopped.
- If the ignition switch remains in the “On” position for a prolonged period after the engine is stopped, the battery voltage will be reduced and this may affect engine’s start capability.
- Lock the steering handle and remove the key before leaving the scooter. Do not leave the key in the ignition switch when leaving the scooter.

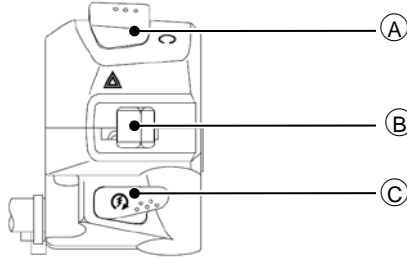

Right Handlebar Switches



A Engine Stop Switch

This switch should normally remain in the  position for the scooter to operate. In an emergency, switch to the  position to stop the engine.

NOTE :

- Even though the engine stop switch can stop the engine, it does not turn off all the electrical circuits. Normally the engine stop switch should be used to stop the engine.

B Hazard Switch

Push the switch left to  position with the ignition switch in "On" position. All the turn signal lights and turn signal indicators will blink.

NOTE :

- Do not use the hazard lights for a long period of time, or the battery may become totally discharged.
- If you turn the ignition switch off without deactivating the hazard lights, the hazard lights cannot be deactivated unless you turn the ignition switch on.

C Starter Button

This starter button operates the electric starter when the engine is not running. Turn the ignition switch on; push this button while holding the front or rear brake lever to start the engine.

NOTE :

- This scooter is equipped with a permanently lit headlight; the position light, tail light, and the license plate light will light up once the ignition switch is turned on. The above mentioned lights cannot be turned off.
- Do not leave the scooter behind too much time after turning the ignition switch on.

Left Handlebar Switches

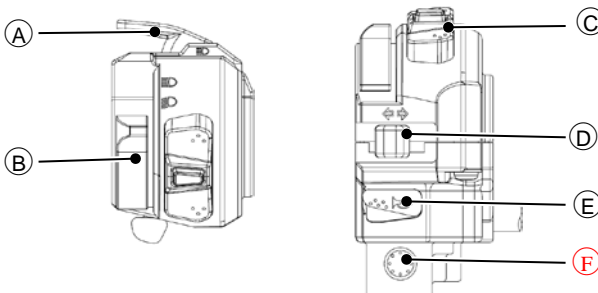





A Passing Light Button

When pushing the passing light button **PASS**, the high beam indicator light goes on to signal the driver of the vehicle ahead that you are about to pass. The passing light is shut off as soon as the button is released.

B Dimmer Switch



High and low beam can be selected with this switch. When the headlight is on high beam , the high beam indicator light goes on (page 10).

-  High beam
-  Low beam

C Menu Switch

The menu buttons are used to control the TFT display on the combination instrument. Please refer to page 11.

D Turn Signal Switch

When the turn signal switch is turned to the left  or right , the corresponding turn signals blink on and off. To stop blinking, push the switch in.

E Horn Button

When the horn button is pushed when the ignition switch is turned on; the horn sounds.

F TCS Button (if equipped)

Push and hold the TCS button to turn on or off the traction control system when the ignition switch is turned on.

Front/Rear Brake Lever

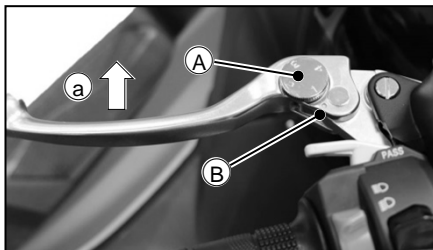

This scooter is equipped with four-position adjustable front/rear brake levers for fitting different hand sizes. To adjust the brake levers, do the below steps:

- Push the brake lever forward **a**.
- Turn the adjuster **A** until the number (position) aligns with the indicative mark **B** while pushing the lever forward.
- Release the brake lever and check that the lever operates correctly.



Windscreen

This scooter is equipped with a 2-position adjustable windscreen. Adjust the positions to fit your figure.

High position: (A)

Low position: (B)

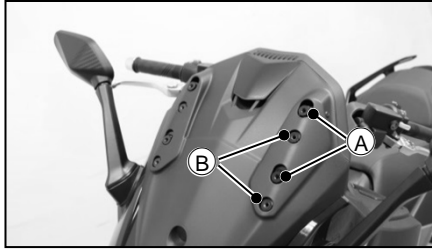

- Remove the 4 bolts (A); select a position that you prefer and mount the windscreen.

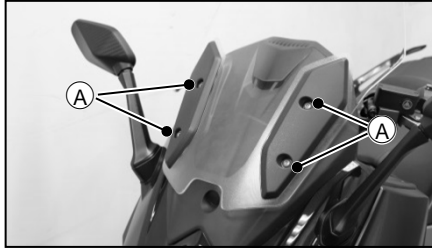

Tightening torque

Windscreen bolt: 1.2 kgf-m

NOTE :

- If you lack proper experience or doubt your ability, please contact your authorized SYM dealer for adjustment.

Fuel Tank Cap

- Turn the ignition key to “Fuel Lid” position (page 20) to release the fuel lid and open it.
- To open the fuel tank cap, flip up (a) the fuel tank cap cover (A), hold the cover and turn it anticlockwise (b).

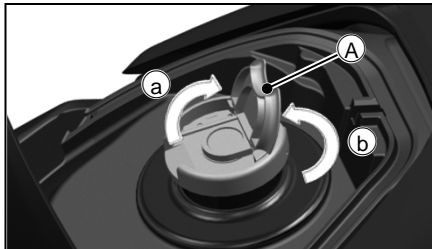



- Put or hold the fuel tank cap securely.
- Fill in the fuel. Do not exceed the bottom of filler neck **A** which is maximum fuel level.

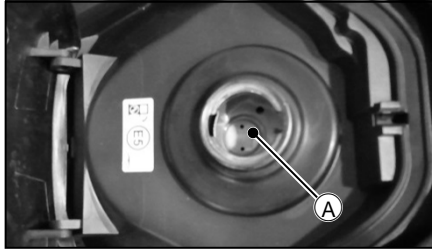

- Close the fuel tank cap and turn it clockwise until it is locked.
- Close the fuel tank cap cover and press the fuel lid to close it.

⚠ CAUTION:

- Gasoline is extremely flammable and can be explosive under certain conditions. Do not smoke and turn the ignition switch off when fueling. Make sure the area is well ventilated and free of any flammable source.
- Never fill the fuel tank to the top. If the tank is filled to the top, heat may cause the fuel to overflow.
- Make sure the fuel tank cap is closed securely after refueling.
- Wipe off the gasoline immediately if it is spilled out on the scooter.

Fuel Requirement

- Fuel type: Unleaded gasoline only.
- Octane number: Research Octane Number (RON) 95 or higher.
- Gasoline / alcohol blends: As known as gasohol, up to 5%.
- Fuel tank capacity: 12.5 L.



⚠ CAUTION:

- Use only unleaded gasoline to prevent engine damage. Leaded gasoline reduces the capability of the catalytic converter in the exhaust system.
- Use recommended octane number. Using lower octane gasoline will cause engine performance to decrease.
- Never use fuels containing high concentration alcohol.
- Do not use contaminated gasoline.



Front Compartment

The two front compartments (A) are located beside the ignition switch. The 2 compartments can be opened by pressing the buttons (B). The USB power outlet (C) is in the right compartment. This power outlet can charge low power consumption devices when the engine is running.

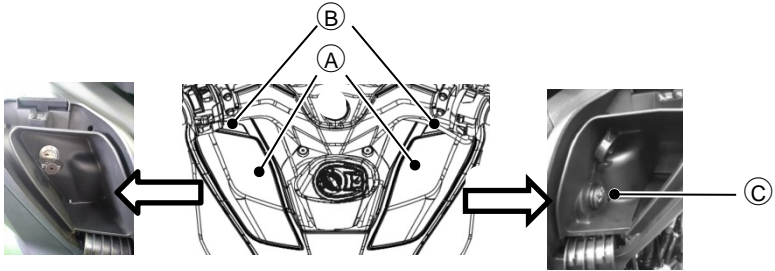

NOTE :

- Do not use the USB power outlet when the engine is not running.
- To prevent the fuse to melt down, do not charge devices exceed 24 W.
- Disconnect devices when leaving the scooter or after riding, and close the USB power outlet cap securely to avoid water infiltration.
- Take away valuables before leaving the scooter.

Luggage Box/Tool Kit/Helmet Hook

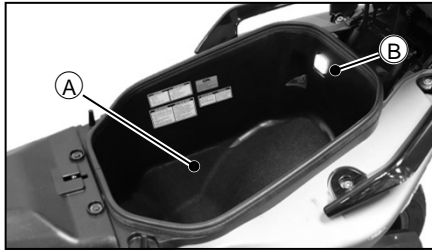

The luggage box (A) is under the seat. Open the seat to use the luggage box. Helmets can be stored in the luggage box. Some helmets may not fit in the space due to the size or design. Please refer to the below picture for recommendation.



a. Small size open face

This scooter is equipped with a luggage box light (B). The luggage box light goes on when the seat is opened.

- Maximum load: 10 kg.

The tool kit is stored in the luggage box, keep the tool kit in the luggage box.



- 10 x 12 mm open end wrench
- C-spanner
- Slotted/Phillips screwdriver
- Screwdriver handle
- Extension bar
- 3 mm Hex key
- T20 Star key

NOTE :

- Do not exceed the maximum weight limit.
- The luggage box may be affected by engine heat. Do not put in valuables, food or objects that are flammable or susceptible to heat damage.
- Take away valuables before leaving the scooter.

The helmet hooks (A) which are located under the seat are designed for securing helmets.

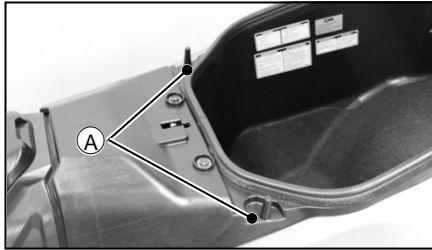

NOTE :

- Riding with helmets attached to the hooks can cause accidents, remove helmets from the helmet hooks before riding.

Side Stand/Parking Brake

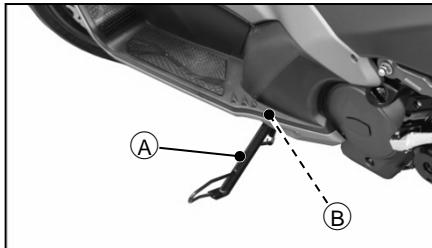

This scooter is equipped with a connective side stand system (A). The side stand is used to park the scooter. The rear wheel is locked after kicking down the side stand. This scooter is equipped with a side stand switch (B). When the side stand is kicked down, the parking brake indicator goes on. The engine cannot be started when the side stand is kicked down. The engine will be stopped when kicking down the side stand while the engine is running.



NOTE :

- Turn the handlebar fully to the left when using the side stand.
- Do not sit on the scooter when it is on its side stand.
- If it is necessary to park the scooter on a slope, do not let the front wheel direct the lower side; the side stand or the parking brake may not perform correctly.
- Always kick the side stand fully up before riding.

Main Stand

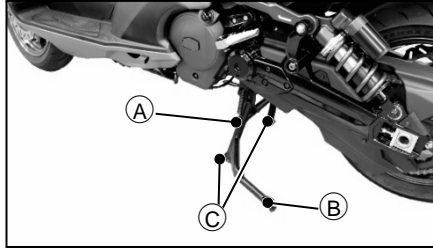

This scooter is equipped with a main stand (A). Use the main stand to park the scooter upright.

- Stand on the left side of the scooter and let down the main stand.
- Hold the left handle grip and the left side of the rear carrier.
- Press down the tip of the stand (B) with your right foot, make sure the 2 contact points (C) touch the surface firmly.
- Pull up and back.
- Turn the handlebar fully to the left.

NOTE :

- If it is necessary to park the scooter on a slope, do not let the front wheel direct the lower side; the main stand may not perform correctly and can cause damage to your scooter.

Rear View Mirror

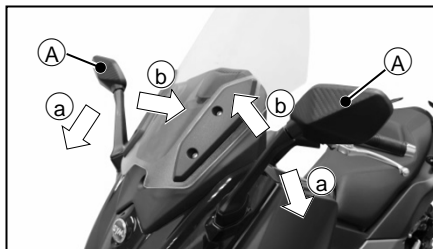

This scooter is equipped with foldable rear view mirrors. The rear view mirrors can be folded forward or backward for parking or storing the scooter. To fold the mirrors, do the below steps:

- Hold the stem securely and turn it forward (a) or backward (b) until it is positioned.
- Return the rear view mirrors to the neutral position (A) before riding.

⚠ CAUTION:

- Never ride the scooter with folded rear view mirrors.



Passenger Footrest

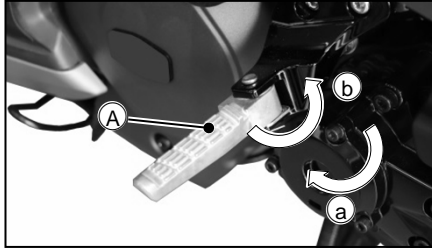

This scooter is equipped with 2 passenger footrests (A). Pull out (a) the footrests for passenger to use, push (b) the footrests to fold up.

NOTE :

- Fold up the passenger footrests when there is no passenger sit on the scooter.

8. How to Start the Engine

To Start the Engine

- Make sure the engine stop switch is in the  position.
- Make sure the side stand is up.
- Turn the ignition key to "ON" position.
- Pull the rear or front brake lever and push the starter button with the completely closed throttle to start the engine.

CAUTION:

- Check the oil and the fuel volume before starting the engine.
- Release the starter button immediately after starting the engine.
- If the engine cannot be started after activating the starter 3 ~ 5 seconds, please slightly open the throttle grip then push the starter button can help starting the engine.
- Do not push the starter button for more than 10 seconds to prevent damaging the starter.
- If the engine cannot be started after several attempts, please turn the ignition switch off and wait 10 seconds for the next start.
- Do not push the starter button while the engine is running.
- The exhaust gas is toxic; please start the engine in areas with good ventilation.

To Stop the Engine

- Completely close the throttle.
- Turn off the ignition switch.
- Position the scooter on a firm, level surface with side stand / main stand down.
- Lock the handlebar.

NOTE :

- This scooter is equipped with a roll-over sensor that can stop the engine automatically when the scooter falls down.



9. How to Ride the Scooter

Break-In

During the first 1000 km of running, follow the below guidelines to ensure your scooter's reliability and performance. Read the following content thoroughly.

- Avoid full throttle starts and rapid acceleration.
- Avoid hard braking.
- Ride the scooter with diverse engine revolution under the below recommended limits.
0~1000 km: Under 5500 rpm.
1000~ km: The scooter can be operated normally, and have your scooter maintained by an authorized SYM dealer.
- Avoid prolonged low speed riding to prevent parts slippage.
- Ride conservatively.

⚠ CAUTION:

- Never run the engine in the red zone of the tachometer during break-in period.
- Do not put excessive load on the engine.
- If any engine problem occurs, have your scooter checked by an authorized SYM dealer.

Tips of Fuel Economy

Your riding style is one of the major factors of fuel consumption. Please refer to the below tips to reduce fuel consumption:

- Avoid high engine speeds when accelerating.
- Avoid high engine speeds without engine load.
- Turn the ignition switch off rather than keeping it idle for a long period of time.

Throttle Control

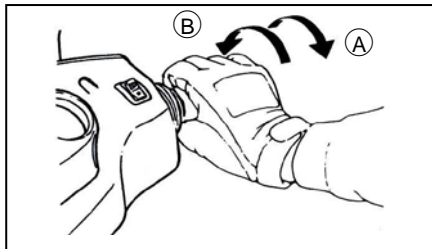

To accelerate, slowly open the throttle ①.

To decelerate, close the throttle ②.

Moving Off

- Make sure the side stand / main stand is up.
- Make sure the surrounding area is clear.
- Smoothly open the throttle to move off



⚠ CAUTION:

- Always open the throttle carefully particularly if you are unfamiliar with the scooter.
- New tires are slippery and may cause loss of control, it is necessary to establish normal tire grip in the break-in period.

Breaking

- Completely close the throttle, the engine will help slowing down the scooter.
- When stopping, always apply both brakes at the same time. Generally speaking, the front brake should be applied a bit more than the rear.
- Never lock the brakes or it will cause the tires to skid. When turning a corner, reduce your speed before getting into the corner.
- Even though this scooter is equipped with ABS, braking during turning a corner may cause wheel slip. It is better to limit and do not apply hard braking force when cornering.
- For emergency braking, focus on applying the brakes as hard as possible.

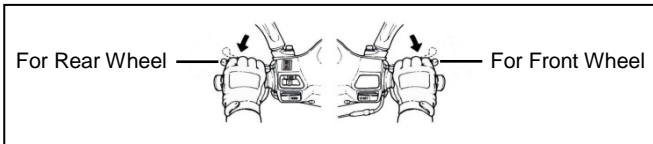

Anti-lock Brake System (ABS)

ABS is designed to help prevent the wheel from locking up when hard brakes are applied while running straight. The ABS automatically regulates brake force. Intermittently gaining gripping force and braking force helps prevent wheel lock-up and allows stable steering control while stopping. Brake control function is identical to that of a conventional scooter. The brake levers are used for the front and rear brakes.

Although the ABS provides stability while stopping by preventing wheel lock-up, remember the following characteristics:

- ABS cannot compensate for adverse road conditions, misjudgment or improper application of brakes. You must take the same care as with scooters not equipped with ABS.
- ABS is not designed to shorten the braking distance. On loose, uneven or downhill surfaces, the stopping distance of a scooter's with ABS may be longer than that of an equivalent scooter without ABS. Use special caution in such areas.
- ABS will help prevent wheel lock-up during straight-up braking, but it cannot control wheel slip which may be caused by braking during cornering. When turning a corner, it is better to limit braking to the light application of both brakes or not to brake at all. Reduce your speed before you get into the corner.
- When the ABS is activating, you can feel tremble from the front/rear brake lever or both levers.

ABS Indicator

The ABS indicator in the combination instrument may go on when the below situation occurs:

- When the engine is started with the main stand raised, and the throttle is opened to make the rear wheel spins.
- Force the front wheel to off the ground while riding (wheelie).
- When the ABS is subjected by strong electromagnetic interference.
- Either tire is different from the standard size, replace with standard size.
- Either rim is deformed, replace the rim.

If the above mentioned happens, turn the ignition switch off and turn it on, then ride the scooter at more than 5 km/h, the ABS indicator should go off. If the indicator does not go off, have your scooter checked by an



authorized SYM dealer.

⚠ CAUTION:

ABS cannot protect the rider from all possible hazards and is not a substitute for safe riding practices. Be aware of how the ABS system operates and its limitations. It is the rider's responsibility to ride at appropriate speeds and manner for weather, road surface and traffic conditions.

Traction Control System (TCS) (if equipped)

This traction control system lowers the engine power output in case of loss of traction in the rear wheel. This system helps maintain traction when accelerating on slippery surfaces, such as wet, muddy or unpaved roads. If sensors detect that the rear wheel is starting to slip, the traction control system intervenes by regulating engine power until traction is recovered.

TCS Indicator

When the ignition switch is turned on, the traction control system is automatically turned on. The traction control system can be turned off when the ignition switch is turned to "On" position; push and hold the TCS button (page 14) for approximately 3 seconds to turn off the traction control system. To turn on the traction control system, push and hold the TCS button for approximately 3 seconds then the TCS indicator will go off. The traction control system can only be turned off and turned back on when the scooter is stationary.

- TCS indicator goes off: with system turned on and scooter in motion, or when system is detecting wheel speeds.
- TCS indicator comes on: with system turned off by rider, or a malfunction occurs. If the system is turned off before starting the engine (with ignition switch in "On" position), this indicator will remain on after the engine is started.
- TCS indicator flashes: when system is intervening.

NOTE :

- The traction control system is automatically turned on whenever the ignition switch is in "On" position, even though the TCS indicator comes on in this condition, the traction control system is turned on.
- When traction control is intervening, you may notice changes in engine response or exhaust sound.
- This traction control system cannot detect sideward slide in the rear wheel while cornering.
- The traction control system does not prevent falls while cornering.
- If the scooter is trapped in mud, sand, or other soft surfaces; turn off the traction control system to free the scooter.
- If it is necessary to ride on low grip surfaces, such as gravel pavement, turn off the traction control system and carefully open throttle to allow the scooter to move on.
- Use only standard size tires. The traction control system will not work properly with non-standard size tires.

Traction control system reset

The traction control system may automatically deactivate (TCS indicator goes on) when the below situation occurs:

- When a wheel speed sensor fault is detected.
- ABS indicator comes on.
- When the EFi warning indicator comes on.

If the above mentioned happens, stop the scooter at a safe place and turn the ignition switch off, and turn it on, then start the engine to reset, the TCS indicator should go off. If the TCS indicator does not go off after resetting, have your scooter checked by an authorized SYM dealer as soon as possible.

NOTE :

- Do not turn off the traction control system and rev the engine when the scooter is on its main stand. The



traction control system will be disabled and need to be reset.

⚠ CAUTION:

- Traction control cannot protect the rider from all possible hazards and is not a substitute for safe riding practices. Be aware of how the traction control system operates and its limitations. It is the rider's responsibility to ride at appropriate speeds and manner for weather, road surface, and traffic conditions.
- Traction control cannot prevent loss of traction due to excessive speed when entering turns, accelerating abruptly at a sharp slope, or while braking, and cannot prevent front wheel slipping.

Park the Scooter

When approaching a parking position:

- Turn on turn indicator in advance, and smoothly close throttle to decrease speed.
- Fully close the throttle and pull brake levers smoothly.

After reaching the parking position:

- Reset the turn indicator switch, and turn the ignition switch off to stop the engine.
- To park the scooter.
- Turn the handlebar to the left and lock the handlebar.

⚠ CAUTION:

- Do not turn the ignition key off while riding.
- The side stand is for uneven ground surface and for short time parking use. Turn the handlebar completely to the left to enhance stability.
- If it is necessary to park the scooter on a slope, do not let the front wheel direct the lower side; the side stand or the parking brake may not perform correctly.
- To avoid heat damage from the exhaust pipe, park the scooter away from pedestrians and children.

10. Maintenance and Adjustment

Importance of Maintenance

The maintenance and adjustments mentioned in this chapter must be carried out in accordance with "Routine Checks" and "Periodic Maintenance Schedule" to keep the scooter in well condition and to reduce air pollution. Maintenance is the owner's responsibility. Be sure to inspect your scooter before every ride and perform the routine checks. The first maintenance is extremely important and must be performed.

⚠ WARNING:

- Always follow the inspection, maintenance recommendations, and schedules in this owner's manual.

SYM cannot warn you of every conceivable hazard that can arise in performance. Only you can decide whether or not you should perform a given task. If you lack proper experience or doubt your ability, please contact your authorized SYM dealer for adjustments, maintenance, and repair work.



Routine Checks

Items	Key points
Engine oil	Correct oil level.
Fuel	Sufficient fuel, no leaking.
Brakes	Front and rear brakes are effective.
Tires	Valve caps are fitted. No puncture. Enough tire pressure.
Drive chain	Drive chain slack, cleaning and lubrication.
Steering handle	Any abnormal vibration or is difficult to turn?
Coolant	Coolant level is correct.
Electrical equipment	Should work effectively.
Tension of main components	Should be tightened correctly.

Oil Level Inspection / Oil Change

Oil Level Inspection:

- If the engine is cold, please warm up the engine several minutes at idle speed.
- Stop the engine and wait for several minutes to allow the oil to settle.
- Set the scooter upright with the main stand and lower the side stand, check the engine oil level through the oil level inspection window (A), the oil level should be between the upper (a) and lower (b) marks.

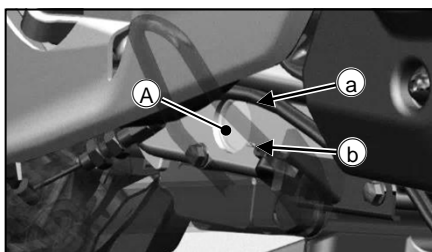

- Top up the oil to the upper mark with the same oil when it is at the lower level. Unscrew the oil filler cap (A) and add engine oil. Install the oil filler cap after adding oil.

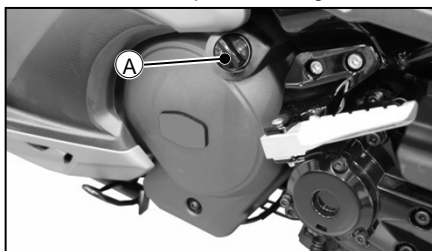

- Please check the oil level every 1,000 km.

⚠ WARNING:

- Revving the engine before the oil reaches every part can cause engine seizure.
- Engine oil is toxic, dispose engine oil properly. Contact your local authorities for recycling method.

NOTE :

- Oil level will not be correct when checking the oil level with the scooter parked on an uneven ground or immediately after the engine stopped.

Oil Change:

The oil change should be done by an authorized SYM dealer. The genuine “**SYMOIL**” are designed and recommended for your scooter.

- Please choose oil grade that is equal to (or greater than) SAE 10W-40, API **SL**, JASO MA. SYM is not responsible for any damage caused by improper oil.
- The first oil change for the scooter is at the first 1,000km, the oil change interval is every 5,000 km from the third oil change.
- Check the air cleaner drain hose, drain it if needed.

Engine oil capacity

Total: 3.5 L

When oil filter cartridge is not removed: 2.7 L

When oil filter cartridge is removed: 2.9 L

Engine oil recommendation

SYMOIL S6800, API SM, JASO MA2 (synthetic).

Tightening torque

Engine oil filter cartridge Ⓐ: 1.8 kgf-m

Engine oil drain bolt Ⓑ: 4.2 kgf-m

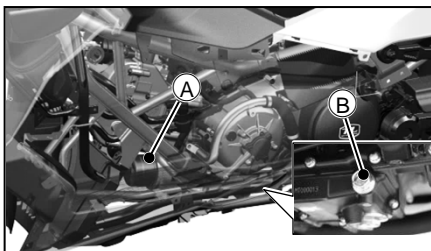

Although SAE 10W40 oil is recommended for most conditions, the oil viscosity may need to be changed to accommodate climate conditions in your riding area.

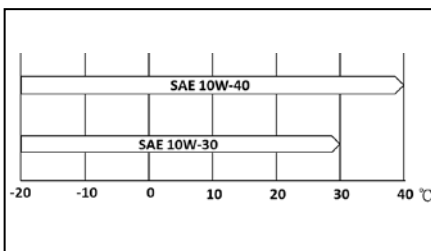

NOTE :

- In order to prevent clutch slip or affect engine life span, do not mix any additives to the engine oil. Do not use any oil labeled “ENERGY CONSERVING” or “RESOURCE CONSERVING”.
- Do not let any foreign object into the crankcase.

Cleaning of Oil Filter Screen:

The oil filter screen (A) should be cleaned by an authorized SYM dealer.

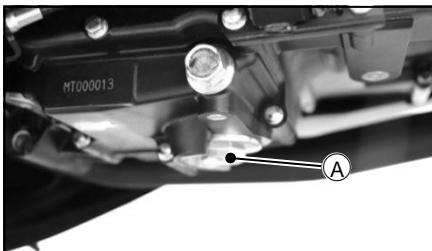

Fuel Inspection

Make sure the fuel is enough for the trip.

- Turn the ignition switch on, and check the fuel gauge. When the low fuel indicator comes on, it shows the fuel remains approximately 2.2 liter (reserve fuel), please fill up the tank immediately.
- Do not add too much fuel to the fuel tank.
- Make sure the fuel tank cap is securely closed.
- Recommended fuel: Unleaded 95 (RON) gasoline or greater.

NOTE :

- If the fuel level signal is in fault, the whole fuel gauge blinks, have your scooter checked by an authorized SYM dealer.

Coolant Level Inspection / Filling

This scooter is filled with high quality coolant that is designed for the cooling system in the factory. It contains a 50% solution of ethylene glycol based antifreeze. Position the scooter on level ground and in an upright position. The coolant inspection window (A) can be seen on the right side of the under spoiler. The coolant level must be between the "F" (a) and "L" (b) marks. Top up the coolant carefully when the level is at the "L" mark.

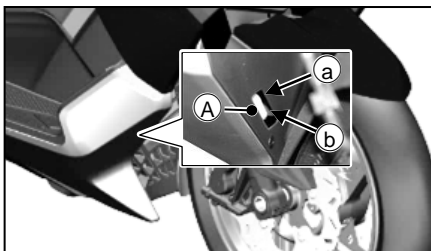

- Pull up the tip of the right front floor panel mat (A) and remove the maintenance cap (B) from its tip.

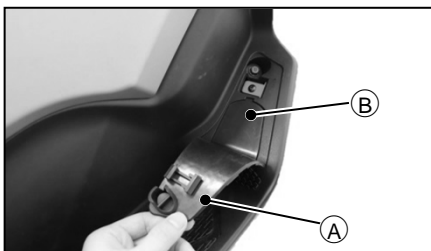

- Open the reserve tank cap (A) to fill in coolant.



- Reverse the above steps to restore.

NOTE :

- You can add soft water to the coolant reserve tank in an emergency, it must be restored to the correct mixture ratio afterwards.
- If you have to add coolant often, the cooling system may have a leakage problem, have your scooter checked by an authorized SYM dealer.

WARNING:

- Never remove the radiator cap when the engine is hot.

Coolant Change

Contact an authorized SYM dealer to have the coolant changed.

It is highly recommended to use “**SYM Long Life Coolant**” or equivalent products when filling or changing coolant. “**SYM Long Life Coolant**” is premixed and contains a 50% solution of ethylene glycol based antifreeze, and does not need to be diluted before topping up or changing. “**SYM Long Life Coolant**” is also contains corrosion inhibitor to protect the cooling system.

- Coolant capacity: 1.4 liters.

Please refer to the below list of antifreeze concentration.

Antifreeze concentration	Temperature	Remark
20%	-8	To ensure antifreeze performance, the original equipped coolant has 50% of antifreeze.
30%	-15	
40%	-24	
50%	-36	

Brake System Inspection

This scooter is equipped with a disk brake system on the front wheel and the rear wheel. If there is something wrong when applying the brakes, have the brake system checked by an authorized SYM dealer.

Front / Rear Brake Fluid Level Inspection:

- Set the scooter upright.
- To inspect the right brake fluid reservoir, turn the handlebar to the left. To inspect the left brake reservoir, turn the handlebar to the right.
- Check the brake fluid level in the front / rear brake fluid reservoir (A).
- With the front brake reservoirs held horizontal, the brake fluid level in the inspection window must be above the “L” line (a).
- If the brake fluid level is below the lower level, contact your SYM authorized dealer to adjust the fluid level.

Recommended brake fluid

DOT 4.

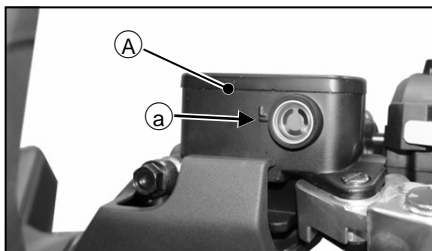

NOTE :

- Brake fluid may harm painted surfaces and plastic parts. Spilled fluid must be cleaned up immediately.
- Refill with the same type of brake fluid.

⚠ WARNING:

- Use only DOT 4 brake fluid.
- Brake fluid is easy to absorb moisture from the air, any absorbed moisture will reduce the braking efficiency greatly.
- Never let water or dirt enter the reservoirs when refilling.
- Contact an authorized SYM dealer immediately if any brake fluid leakage is found.

Front / Rear Brake Pad Inspection:

If you feel something is wrong when applying the brakes, have your scooter checked by an authorized SYM dealer.

- Inspect the front brake pads **(A)** and the rear brake pads **(B)** wear of both disk brake calipers.
- If any groove indicator **(a)** is nearly worn out, have the brake pads replaced by an authorized SYM dealer.

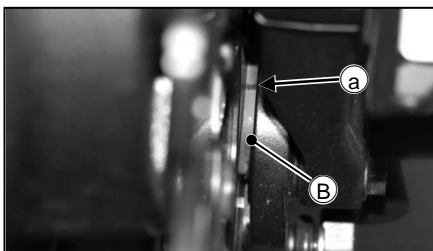
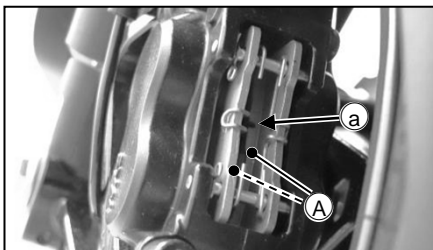

NOTE :

- Brake pads must be always replaced as a set.
- New brake pads require a break-in period.

Throttle Free Play Inspection

- Check that the throttle grip moves smoothly from full open to close.
- Check that there is 5°~ 10° **(A)** of throttle free play when turning the throttle grip back and forth.
- Have the throttle free play checked by an authorized SYM dealer.

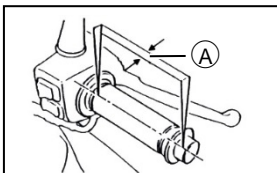



Tire / Tire Pressure Inspection

- Remove the air valve cap.
- Measure the tire pressure with a tire pressure gauge (A) often and inspect the tires to the recommended tire pressure.

Recommended air pressure for standard tire MAXXIS SUPERMAXX S3

Front: 2.3 kgf/cm² , 32 psi (120/70-R15 56H)

Rear: 2.8 kgf/cm² , 39 psi (160/60-R15 67H)

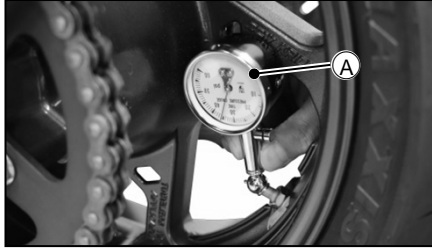

- Visually inspect the tire for cracks and cuts (A) before riding, replace the tires when necessary.

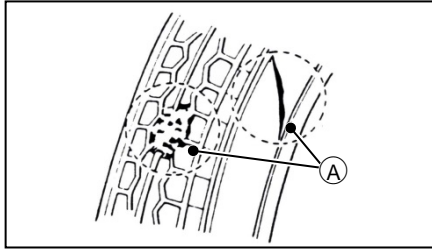

- Measure the depth of the tread with a depth gauge (A), replace the tire that has worn down to the minimum allowable tread depth.

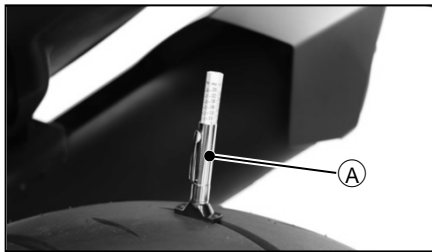

⚠ WARNING:

- Insufficient tire tread depth can make the scooter difficult to control.
- Please refer to the local regulations about tire tread depth.
- New tires are slippery and may cause loss of control. Smoothly operate the scooter during break-in period for the new tires.
- Mixing different brands or types of tires can adversely affect handling and may cause fatal injuries.



Steering / Front Fork Inspection

- Visual inspect that the front forks (A) are damaged or have oil leakage.
- Compress the front forks by pushing down the steering handle (B) to check that the forks can be operated smoothly.
- Check that the steering axle locknut is tightened.
- If any irregularity is found on the handlebar / front fork, contact your authorized SYM dealer.

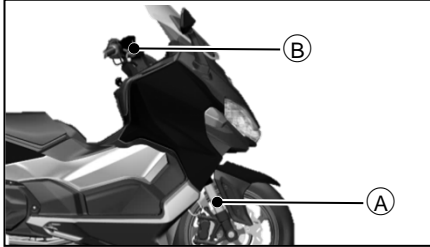

Fuse Inspection

Fuses are arranged in the fuse box located behind the front right cover (A).

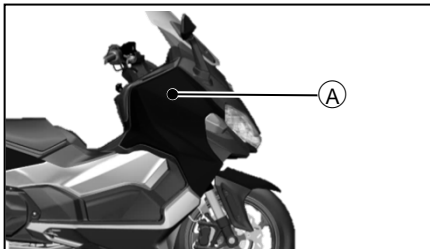

To remove the front right cover, follow the below steps.

- Turn ignition switch off and set the scooter up right.
- Open the right storage compartment cover and remove the 2 screws (A).

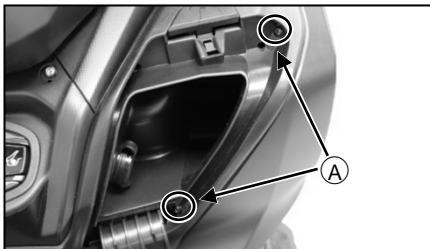



- Remove the 2 screws (A) on the rear side of the front right cover.

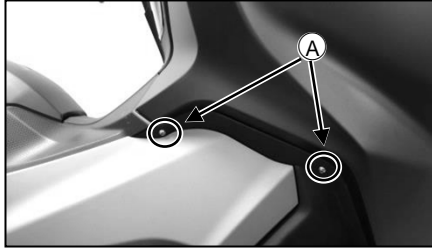

- Remove the 2 screws (A) and the 2 plastic nuts (B).

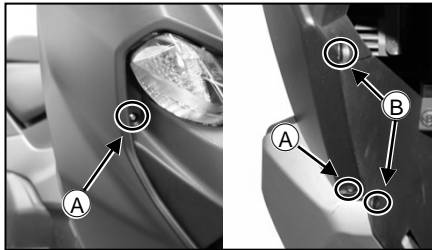

- Carefully pull the front right cover outward, take care of the 3 tenons (A).
- Open the fuse box to check the fuses (B).

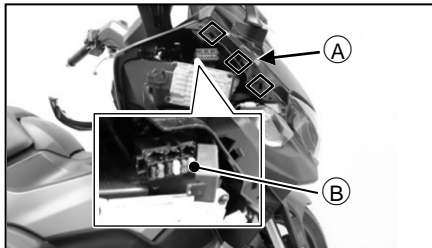

- Reverse the above steps to restore.

If a fuse fails, inspect the electrical system to determine the cause, and replace it with a new fuse of proper amperage or have the fuses replaced by an authorized SYM dealer. Do not replace it with any material other than the specified fuse. Have the scooter checked by an authorized SYM dealer if the fuse fails repeatedly.

Battery Inspection

Battery Inspection

This scooter is equipped with a sealed type battery. There is no need to check the electrolyte level or add distilled water. The battery is located behind the front right cover.

To take out the battery, do as the following instructions.

- Remove the front right cover, refer to Fuse Inspection.
- First disconnect the (-) terminal cable (A) then the (+) terminal (B).
- Remove the battery band (C) and take out the battery carefully.

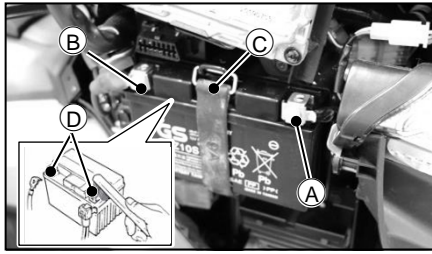

- Clean the terminals ④ by using solution of baking soda and water.
- To install the battery, do in the reverse order of the above instructions.

Battery type

TTZ-10S

Battery Maintenance

Keeping the battery fully charged is the owner's responsibility. If you failed to do so, it can cause battery failure and leave you stranded. If you ride the scooter rarely, inspect the battery voltage weekly with a voltmeter. If the voltage drops below 12.0 V, use a suitable motorcycle battery charger to charge the battery. Follow the instructions of the battery charger to charge the battery. Contact your authorized SYM dealer for suitable battery chargers.

⚠ WARNING:

- Electrolyte is poisonous and dangerous since it contains sulfuric acid that can cause severe damage. Avoid any contact with human body or clothing, always protect your eyes when working with a battery.
- A battery produces explosive hydrogen gas; keep sparks, flames away from the battery and provide well ventilation when charging it.
- Keep children away from the battery.

Drive Chain Inspection

Drive Chain Slack Inspection

Inspect the chain slack before riding.

- Turn ignition switch off and set the scooter upright with its main stand.
- Remove the 2 screws ① and the 2 bolts ② to remove the outer lower chain guard.

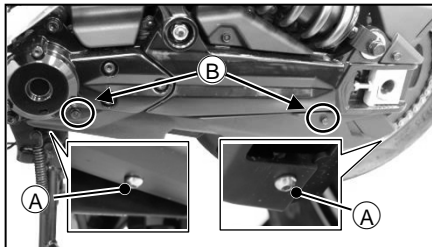

- Rotate the rear wheel to find the tightest position of the chain and measure the chain slack ① by pushing up and pulling down the chain midway between the front sprocket and rear sprocket.



Drive chain slack

Standard: 10–15 mm

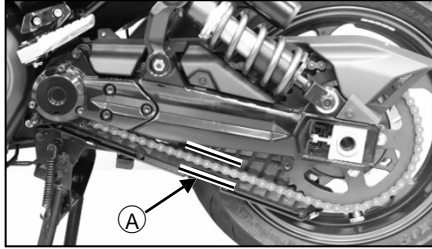

- If the drive chain is too tight or too loose, have the chain slack adjusted by an authorized SYM dealer.
- Mount the outer lower chain guard to restore.

Tightening torque

Outer lower chain guard bolt: 1.2 kgf-m

Also inspect the two sprockets. If either has worn or damaged teeth, have the sprockets replaced by an authorized SYM dealer.

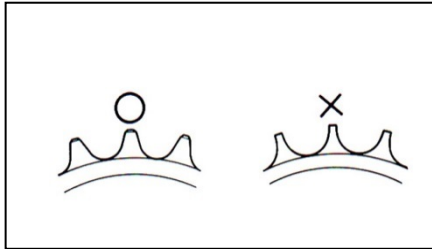

NOTE :

- Use of a new chain with worn sprockets can cause unnecessary chain wear.

Drive Chain Lubrication

The drive chain must be cleaned and lubricated at the intervals specified in the periodic maintenance table to prevent deterioration of chain seals. The drive chain will quickly wear out especially when riding in dusty or wet areas. Clean and lubricate the drive chain with sealed chain cleaner and lubricant as follows.

- Remove the front lower chain guard.
- Clean the drive chain with sealed chain cleaner and a soft brush.
- Wipe the chain dry.
- Lubricate the drive chain thoroughly with sealed chain lubricant. Wipe off excessive lubricant on the drive chain and the rear tire.
- Mount the lower chain guard to restore.

NOTE :

- Clean and lubricate the drive chain after riding in rain or wet areas.
- Do not clean the drive chain with high pressure water or any other inappropriate method.
- Do not use engine oil or any other lubricants for the chain, they may contain substances could damage the sealed chain.



Spark Plug Inspection

Have the spark plug checked by an authorized SYM dealer. If the electrodes are contaminated with heavy deposits or the insulator is damaged, replace with a new one. Measure the spark plug gap (A) with a wire type feeler gauge. The gap should be within 0.8 ~ 0.9 mm. If adjustment is needed, bend the side electrode (B) carefully.

Recommended spark plug

NGK CPR7EA-9

Spark plug gap

0.8 ~ 0.9 mm

Tightening torque

1.2 kgf-m

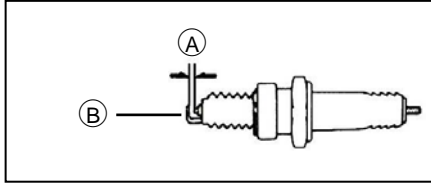

⚠ WARNING:

- Beware of the engine heat when inspecting the spark plug.

Engine Air Cleaner / V-belt Case Air Cleaner Inspection

A dirty engine air cleaner element can reduce the engine performance and increase fuel consumption. The engine air cleaner element is located behind the front left cover (A).

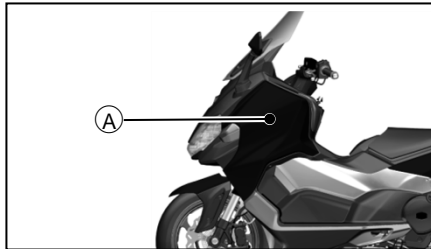

Inspect the engine air cleaner by following the below instructions.

- Turn ignition switch off and set the scooter upright.
- Open the left storage compartment cover and remove the 2 screws (A).

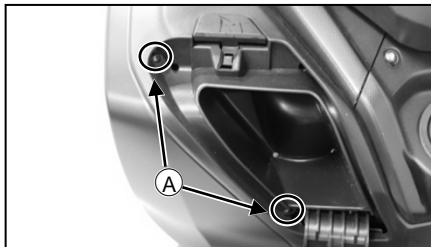

- Remove the 2 screws (A) on the rear side of the front right cover.

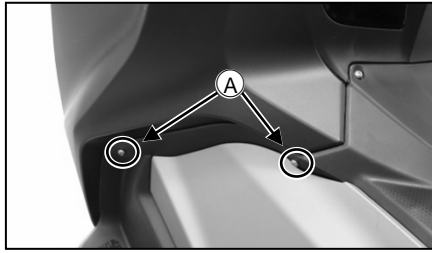

- Remove the 2 screws (A) and the 2 plastic nuts (B).

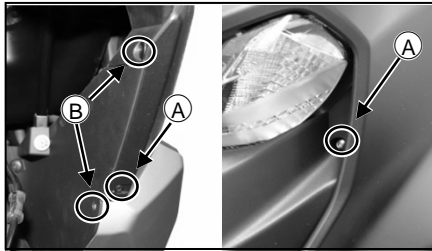

- Carefully pull the front left cover outward, take care of the 3 tenons (A).
- Remove the 5 screws (B) to remove the air cleaner element (C).

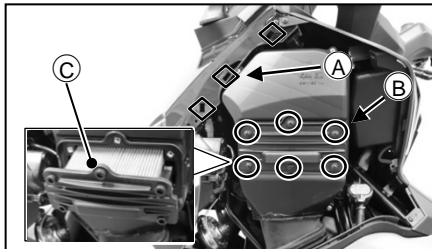

- Clean the dust groove (A) with a wet cloth after removing the air cleaner element.

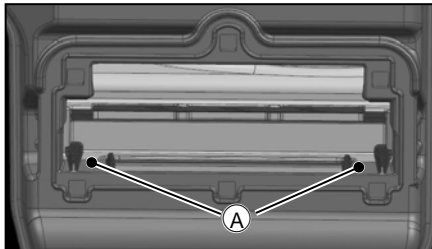

- If the air cleaner element is damaged or too dirty, have it changed by a SYM authorized dealer.
- To install the element, do in the reverse order of the above instructions.

This scooter is equipped with 2 V-belt air cleaner elements. Have the v-belt air cleaner elements inspected or replaced by an authorized SYM dealer.



NOTE :

- Make sure to keep dust or foreign objects from entering the air cleaner during inspection.
- The dust groove must be cleaned before installing the air cleaner element.
- Use SYM genuine air filter element to ensure the engine performance.

Headlight Adjustment

The headlight aim can be adjusted for proper alignment. Use a Phillips screwdriver to adjust the low beam vertical adjuster (A) or the hi beam vertical adjuster (B). Headlight aiming should be performed by an authorized SYM dealer.

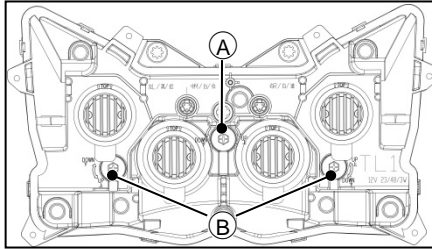

NOTE :

- Obey local regulations for headlight aiming adjustment.

Rear Shock Absorber Adjustment

This scooter is equipped with a position-free spring preload adjustable rear shock absorber. To adjust the preload setting, follow the below steps.

- Set the scooter up right with the main stand.
- To set the spring harder, turn the adjuster (A) clockwise (a) with the C-spanner (C) in the toll kit to increase preload. After setting up the spring, turn the fixer (B) clockwise to lock the spring.
- To set the spring softer, first turn the fixer anti-clockwise to release, turn the adjuster anti-clockwise (b) with the C-spanner in the tool kit to decrease preload, then turn the fixer clockwise to lock the spring.

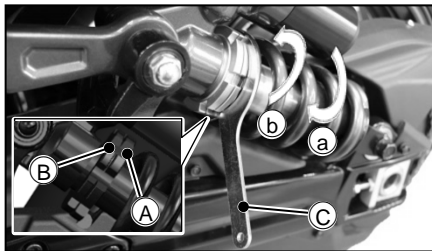

NOTE :

- Do not exceed the adjuster's limit.
- Be sure to lock the spring with the fixer after setting up the preload.



General Lubrication

Lubricate the below parts with either engine oil or general grease in accordance with the “Periodic Maintenance Table” or whenever the vehicle has been operated under wet or rainy conditions. Clean off rusty spots and wipe off any oil or grease.

- Side stand pivot.
- Main stand pivot.
- Front / rear brake lever pivots.
- Throttle cables.
- Parking brake cable.

Vehicle Data Recorder

This scooter is equipped with an ECU that can record or collect vehicle data for trouble diagnosis and research. The data must be received by a special diagnostic tool when carrying out maintenance or check-up. SYM will not transfer the data to any third party except:

- The owner or user agrees.
- Stipulated by laws.
- In need of lawsuit.
- For research and development, and the data is irrelevant to an individual unit or the owner.

11. Taking Care of Your Scooter

Washing

Fully cool down the engine, muffler, brakes and other high-temperature parts before washing. We suggest you to cover the muffler’s exhaust vent and shut the ignition switch slot.

- Rinse your scooter with cold water from a water hose to remove dirt.
- Mix a neutral detergent that is designed for scooters or automobiles and water in a bucket. Use a sponge to wash your scooter.
- Use low pressure water stream to clean the radiator.
- After washing, rinse your scooter thoroughly with clean water to remove the residue.
- Use an air gun to blow off the water and use a clean soft cloth to dry your scooter.
- Carefully ride your scooter at a slow speed and apply the brakes several times to help drying the brakes.

NOTE :

- Do not rinse the radiator with high water pressure.
- After riding in an area where the roads are salted, wash the scooter as soon as possible.
- Specially take care of the matt color plastic parts if they are equipped. Never wax matt color parts.

Clean the windscreen with a solution of mild detergent and cold water. Rinse well after cleaning and then dry with a clean soft cloth. If the transparency of the windscreen is reduced by scratches or contamination that cannot be removed, have the windscreen replaced by an authorized SYM dealer.

⚠ WARNING:

- Never try to clean the windscreen while the scooter is in motion to prevent accidents from happening.
- Operation of the motorcycle with a damaged or scratched windscreen will reduce riders’ forward view. Any such reduction in forward view is dangerous and can cause severe accidents.

⚠ CAUTION:

- Corrosive chemicals such as battery acid can damage the windscreen.



Storage

If you plan to store the scooter for a long period, perform the following steps.

- Have the scooter cleaned thoroughly.
- Run the engine for several minutes and shut it off, then drain out the engine oil.
- Add new engine oil.
- Fill up the fuel tank with fuel, add fuel stabilizer if available to prevent the fuel tank from rusting and the fuel from deteriorating.
- Reduce about 20% tire pressure. Have the scooter's two wheels raised off the ground.
- Carefully apply thin oil on all unpainted metal surfaces to prevent rusting.
- Lubricate all cables and the drive chain.
- Remove the battery and have it fully charged. Store it in a cool, dry place and charge it once a month. Make sure the battery is well charged during cold weather.
- Cover plastic bag over the muffler to avoid moisture to get in.
- Cover the whole scooter to protect it from dust and dirt.

NOTE :

- Make any necessary repairs before storing the scooter.

⚠ WARNING:

- Engine oil is toxic, recycle used oil properly.

12. Trouble Shooting

Diagnosis When Engine Does Not Start

- Is the ignition switch turned to "ON" position?
- Is there enough fuel in the fuel tank or there is only E mark shown in the fuel gauge?
- Is the rear or front wheel brakes applied when pressing start button?
- Turn the ignition switch to "ON" position, and press the horn button, if the horn does not sound, the fuse may have been blown.
- Remove the front right cover to check the fuses, if the wire is obvious melted, replacement is needed.
- Is the side stand kicked down?
- When the EFi warning indicator goes on and stays on, contact an authorized SYM dealer for inspection.
- Leaving the scooter unused for a long period of time without adding fuel stabilizer, contact an authorized SYM dealer for inspection.

If the engine still cannot be started after completing the above inspection, contact an authorized SYM dealer for further inspection.

⚠ WARNING:

- Replacing fuses can cause wiring to overheat. Use only standard fuses of the correct specifications or have the fuses replaced by an authorized SYM dealer.

Overheating

The engine is overheating when the below symptom occur:

- The high coolant temperature indicator comes on.
- Sluggish acceleration.



Pull safely to the road side and perform the below procedure.

- Turn the ignition switch off to stop the engine then turn the ignition switch on.
- Check the operation of the radiator fan then turn off the ignition switch.

If the fan is not operating, do not start the engine and transport your scooter to an authorized SYM dealer. If the fan is operating, cool down the engine, inspect the cooling system hose and check if there is a leak. If there is a leak, do not start the engine and transport your scooter to an authorized SYM dealer.

NOTE :

- Do not deflect airflow through the radiator by installing unauthorized accessories in front of the radiator.

Efi Warning Indicator On

If this indicator comes on while riding, you may have a serious EFi system problem. Contact your authorized SYM dealer as soon as possible.

ABS Indicator On

If this indicator light comes on in the below conditions, you may have a serious brake system problem.

- The indicator light comes on while riding.
- The indicator light does not come on when the ignition switch is turned on.
- The indicator does not go off above 5 km/h.

Although the brake system will continue to work without anti-lock function, SYM suggest you to have your scooter checked by an authorized SYM dealer if any of the above symptoms occurs.

Low Oil Pressure Indicator On

If the low oil pressure indicator light comes on, stop the scooter safely at road side and turn off the engine, and check engine oil level.

- If the engine oil is insufficient, add engine oil.
- If the engine oil level is good, have your scooter checked by an authorized SYM dealer.

⚠ WARNING:

- Continue riding with low oil pressure can cause serious damage to the engine.
- Only continue riding when the low oil pressure indicator goes off.
- Do not let any foreign objects get into the engine.



13. Periodic Maintenance

	Item	Odometer Reading					Annual service	Page
		1,000km	10,000km	20,000km	30,000km	40,000km		
1	☆ Valve clearance				I			
2	☆ Engine air cleaner element*		R	R	R	R		44
3	☆ V-belt case air cleaner elements*		C	R	C	R		44
4	☆ Engine oil*#	R	Second at first 5,000km, every 5,000km thereafter				R	33
5	Engine oil filter screen*#	C	Second at first 5,000km, every 5,000km thereafter				C	35
6	☆ Engine oil filter cartridge*#	R	R	R	R	R		34
7	Engine oil level	I: every 1,000km						33
8	☆ V-belt*	R: every 20,000km						
9	Drive chain lubrication condition*#	I: every 500km					I	43
10	Drive chain slack	I: every 1,000km						42
11	Drive chain/sprockets wear		I	I	I	I		43
12	Drive chain	R: every 15,000km						-
13	Drive chain slider							
14	☆ Spark plugs		I/R	I/R	I/R	I/R		44
15	☆ Idle speed	I	I	I	I	I		-
16	Cooling system#		I	I	I	I	I	-
17	Coolant level	I	I	I	I	I		36
18	☆ Coolant, water hoses and O-rings [†]	R: every 3 years					I	-
19	Throttle control system#	I	I	I	I	I	I	38
20	☆ CVT system (rollers/shafts/drive pulley cushion)			I/L/R		I/L/R		-
21	Brake system#	I	I	I	I	I	I	-
22	Brake operation	I	I	I	I	I	I	
23	☆ Brake fluid	R: every 2 years or every 30,000km					I	
24	Brake fluid level	I	I	I	I	I	I	37
25	☆ Brake hoses	R: every 4 years or every 60,000km					I	-
26	Brake pad wear*		I	I	I	I		38
27	Brake light switch operation#	I	I	I	I	I	I	-
28	Suspension system#		I	I	I	I	I	-
29	Wheels and tires#	I	I	I	I	I	I	39
30	Tire pressure#	I	I	I	I	I	I	39
31	☆ Wheel bearings		I	I	I	I		-



	Item	Odometer Reading					Annual service	Page
		1,000km	10,000km	20,000km	30,000km	40,000km		
32	☆ Evaporative emission control system		I	I	I	I		-
33	☆ Fuel system [#]	I	I	I	I	I	I	-
34	☆ Fuel hose [#]	R: every 5 years					I	-
35	☆ Steering stem bearings		I	L	I	L		40
36	Pivots and cables		L	L	L	L		-
37	☆ Electrical system [#]		I	I	I	I	I	-
38	☆ Bolts, nuts and fastener condition	I	I	I	I	I		-

I: Inspect or adjust

C: Clean

R: Replace

L: Lubricate

*: Service more frequently when riding in severe conditions such as dusty, wet, muddy, high speed, etc.

[#]: Service annually or at indicated odometer reading intervals, whichever comes first.

☆: Should be performed by an authorized SYM dealer.

- For higher odometer readings, repeat at the frequency shown above.
- If any problem raised about your scooter, please contact your SYM authorized dealer regardless the service schedule.



14. Specification

		MAXSYM TL, TL 500 (TL50W2-EU)
Frame	Overall length	2,215 mm
	Overall width	801 mm
	Overall height	1,439 mm
	Wheel base	1,543 mm
	Ground clearance	145 mm
	Caster	25°
	Trail	92 mm
	Min. turning radius	2.75 m
	Maximum load	190 kg
	Curb weight	227 kg
	Luggage box capacity	37 L
	Seat height	795 mm
	Fuel tank capacity	12.5 L
	Engine	Type
Compression ratio		10.9:1
Displacement		508 cm ³
Bore × stroke		68 mm × 70 mm
Max. horse power		45.6 PS @ 6750 rpm
Max. torque		5.1 kg-m @ 5250 rpm
Idle speed		1,300 rpm
Starting system		Electric starter
Fuel system		EFI (fuel injection)
Fuel		Unleaded 95 (RON) gasoline or greater
Ignition system		Battery and coil
Spark plug		NGK CPR7EA-9
Coolant capacity		1.4 L
Drivetrain	Clutch	Wet, centrifugal, multi disc
	Transmission	V-belt CVT
	Final drive	Chain drive
	Final reduction ratio	2.813
Lubrication System	Engine oil	SAE 10W40~SAE 20W-50, API SL, JASO MA or greater
	Lubrication system	Forced, dry sump
	Engine oil capacity (total)	3.5 L
	Engine oil capacity (change)	2.7 L (without filter cartridge) / 2.9 L (with filter cartridge)



		MAXSYM TL, TL 500 (TL50W2-EU)
Brake System	Front / rear tire	120/70-R15 56H, 160/60-R15 67H
	Front / rear tire pressure	2.3 kgf/cm ² (32 psi), 2.8 kgf/cm ² (39 psi)
	Front / rear rim	15 × MT 3.5, 15 × MT 5.0
	Rim material	Aluminum alloy
	Front brake disk	275 mm × 2
	Rear brake disk	275 mm
	Front brake caliper	4-piston (ABS) × 2
	Rear brake caliper	1-piston (ABS)
	Brake fluid	DOT 4
Suspension System	Front	Upside down fork, 41 mm
	Rear	Multi-link single-sided shock absorber, preload adjustable
Electrical Equipment	Head light	LED
	Rear / brake light	LED
	Turn indicator	LED
	License plate light	5 W
	Battery	MF, TTZ-10S, 12V 8.6Ah

* Specifications or equipment are subject to change without notice.